

Service Manual

AIR CONDITIONER



Supplement

CS-A24BD3P CU-A24BBP5
 CS-A28BD3P CU-A28BBP5
 CS-A28BD3P CU-A28BBP8
 CS-A34BD3P CU-A34BBP5
 CS-A34BD3P CU-A34BBP8
 CS-A43BD3P CU-A43BBP8
 CS-A50BD3P CU-A50BBP8
 CS-A24BD3P CU-C24BBP5
 CS-A28BD3P CU-C28BBP5
 CS-A28BD3P CU-C28BBP8
 CS-A34BD3P CU-C34BBP5
 CS-A34BD3P CU-C34BBP8
 CS-A43BD3P CU-C43BBP8
 CS-A50BD3P CU-C50BBP8

Subject : Correction in Sound Data and Indoor Unit Replacement Parts.

Please file and use this supplement manual together with the service manual for Model No. CS-A24BD3P/CU-A24BBP5, CS-A28BD3P/CU-A28BBP5, CS-A28BD3P/CU-A28BBP8, CS-A34BD3P/CU-A34BBP5, CS-A34BD3P/CU-A34BBP8, CS-A43BD3P/CU-A43BBP8, CS-A50BD3P/CU-A50BBP8, CS-A24BD3P/CU-C24BBP5, CS-A28BD3P/CU-C28BBP5, CS-A28BD3P/CU-C28BBP8, CS-A34BD3P/CU-C34BBP5, CS-A34BD3P/CU-C34BBP8, CS-A43BD3P/CU-C43BBP8, CS-A50BD3P/CU-C50BBP8, Order No. MAC0111069C0.

WARNING

This service information is designed for experienced repair technicians only and is not designed for use by the general public. It does not contain warnings or cautions to advise non-technical individuals of potential dangers in attempting to service a product. Products powered by electricity should be serviced or repaired only by experienced professional technicians. Any attempt to service or repair the product or products dealt with in this service information by anyone else could result in serious injury or death.

CONTENTS

	Page	Page
1 SOUND DATA (Pages: 68 ~ 70)	2	2
2 REPLACEMENT PARTS (Pages: 124 ~ 127)		5

1 SOUND DATA (Pages: 68 ~ 70)

CS-A24BD3P

Octave Band Central Frequency (Hz)

External Static Pressure 49Pa (5mmAq)

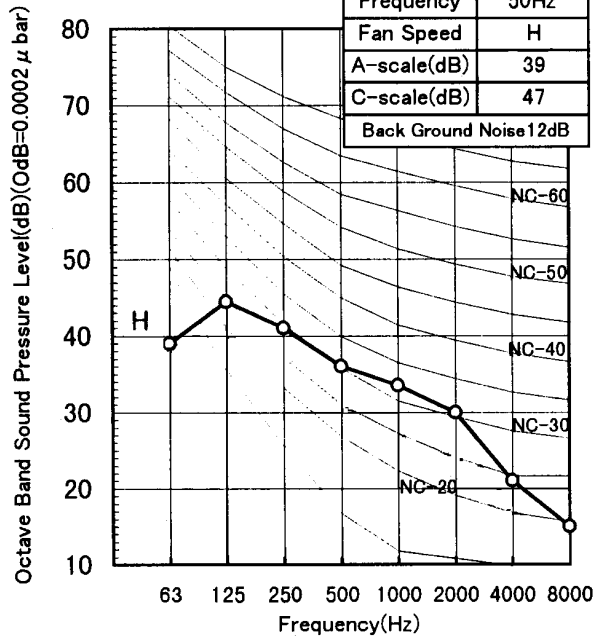

CS-A24BD3P

Octave Band Central Frequency (Hz)

External Static Pressure 69Pa (7mmAq)

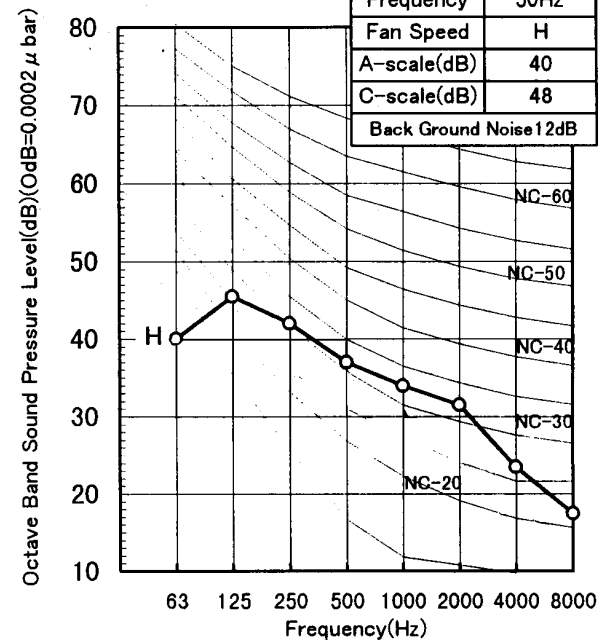

CS-A28BD3P

Octave Band Central Frequency (Hz)

External Static Pressure 49Pa (5mmAq)

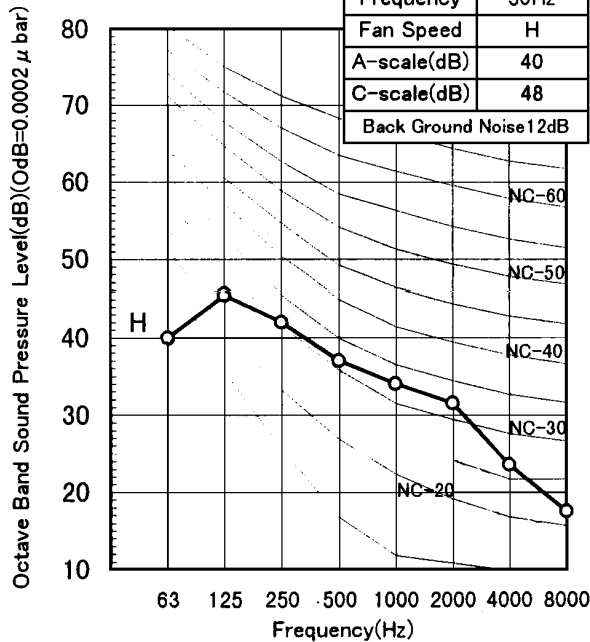

CS-A28BD3P

Octave Band Central Frequency (Hz)

External Static Pressure 69Pa (7mmAq)

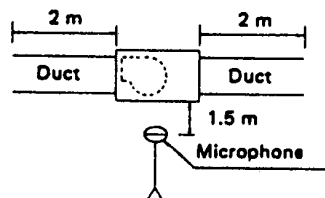
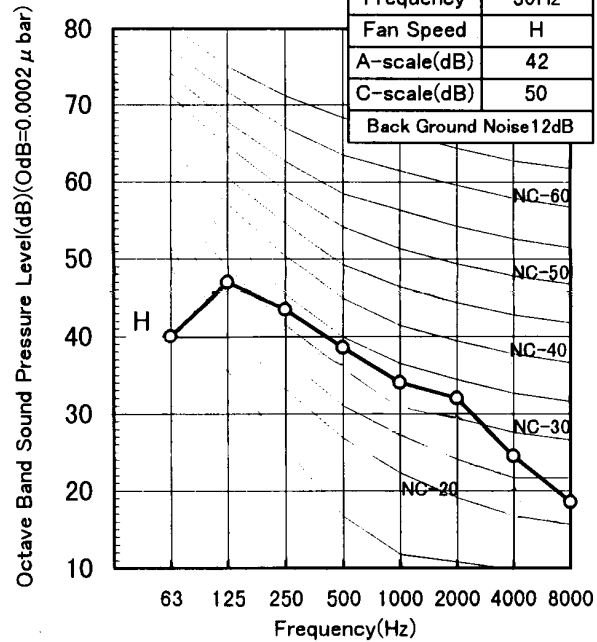

CS-A34BD3P
 Octave Band Central Frequency (Hz)
 External Static Pressure 49Pa (5mmAq) H ○—○

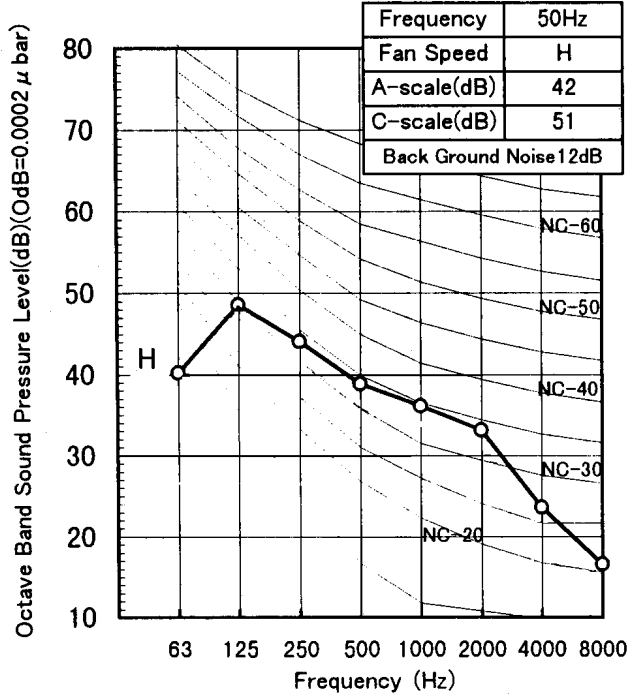

CS-A34BD3P
 Octave Band Central Frequency (Hz)
 External Static Pressure 69Pa (7mmAq) H ○—○

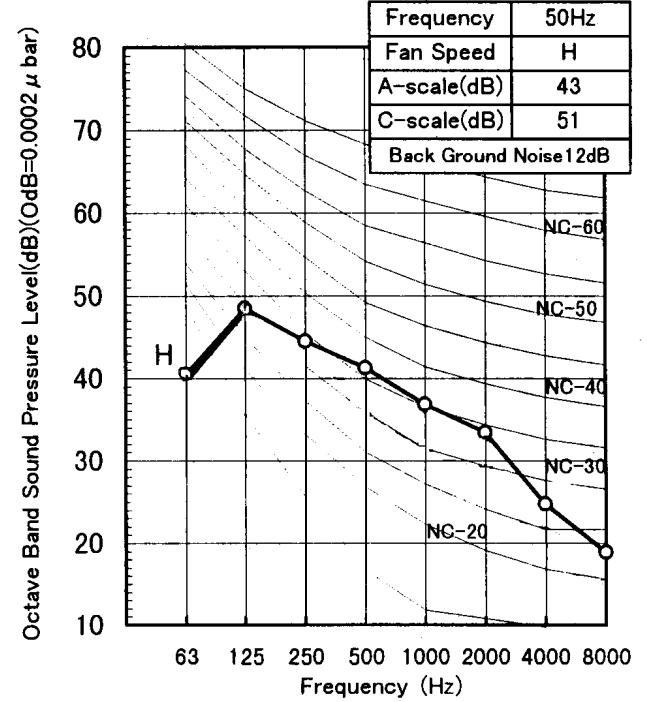

CS-A43BD3P
 Octave Band Central Frequency (Hz)
 External Static Pressure 49Pa (5mmAq) H ○—○

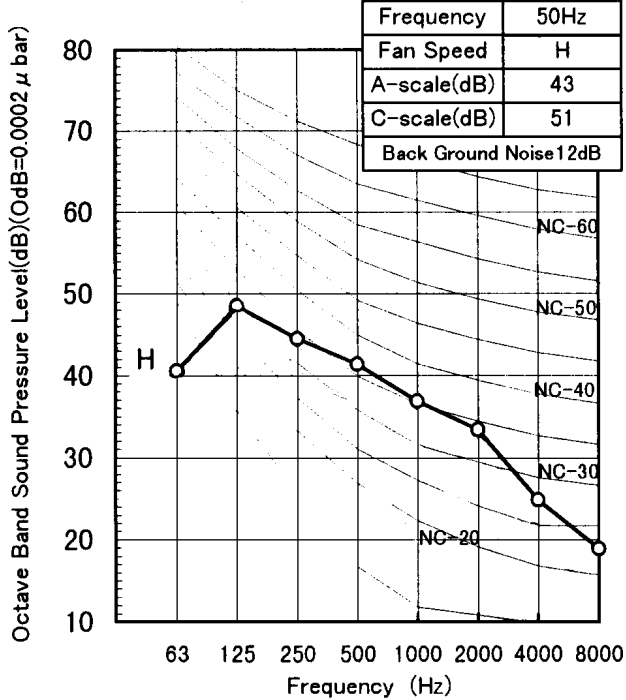

CS-A43BD3P
 Octave Band Central Frequency (Hz)
 External Static Pressure 69Pa (7mmAq) H ○—○

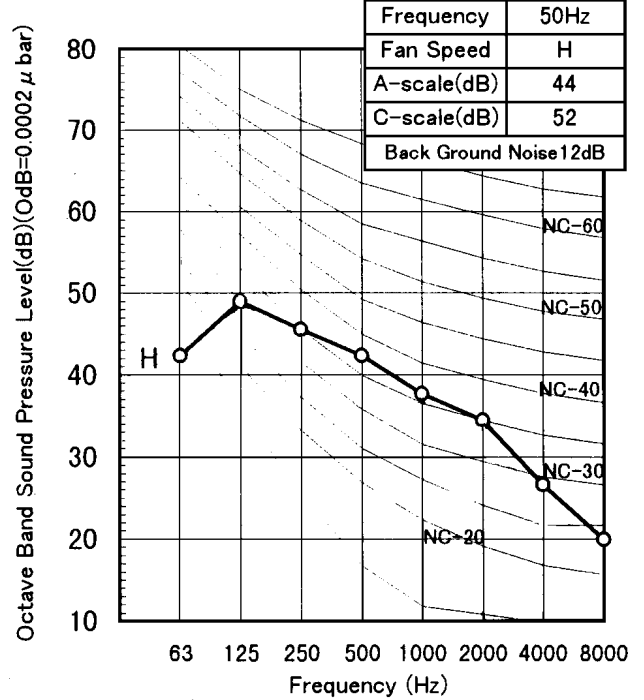

CS-A50BD3P

Octave Band Central Frequency (Hz)

External Static Pressure 49Pa (5mmAq)

H ○—○

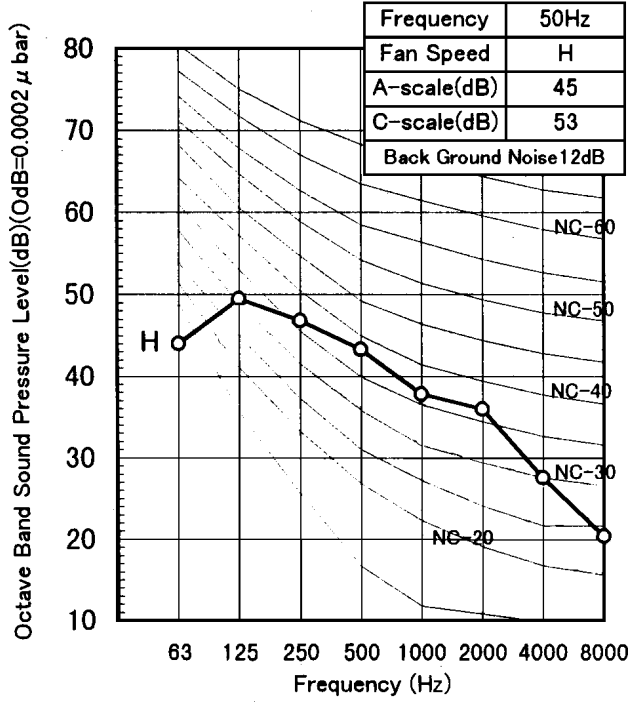

CS-A50BD3P

Octave Band Central Frequency (Hz)

External Static Pressure 69Pa (7mmAq)

H ○—○

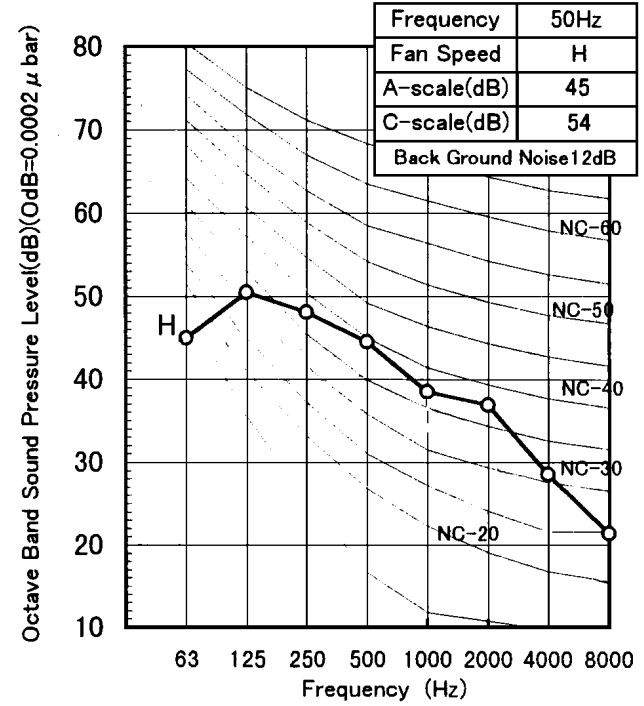

NOTE:

: Microphone Position

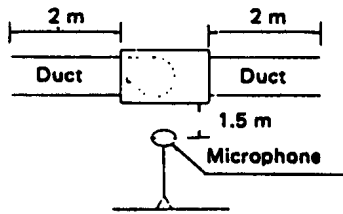

2 REPLACEMENT PARTS (Pages: 124 ~ 127)

2.1. INDOOR UNIT

CS-A24BD3P, CS-A28BD3P

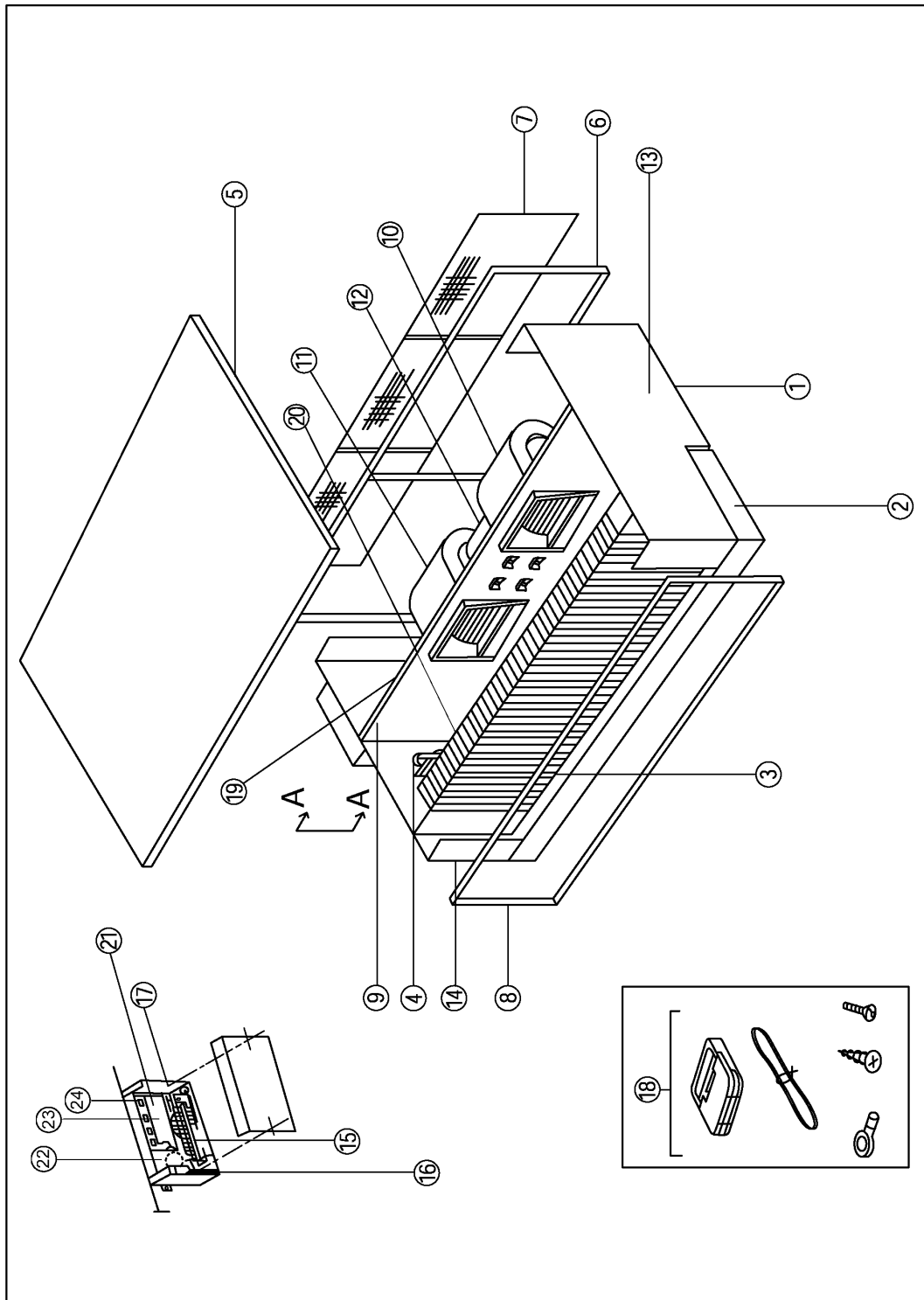

REF. NO.	PARTS NAME	PARTS NUMBER	QUANTITY PER 1 UNIT	
			CS-A24BD3P	CS-A28BD3P
24	Wire Harness Ass'y IHA	P46-T04000	1	1

All parts are supplied from Taiwan (Tamaco).

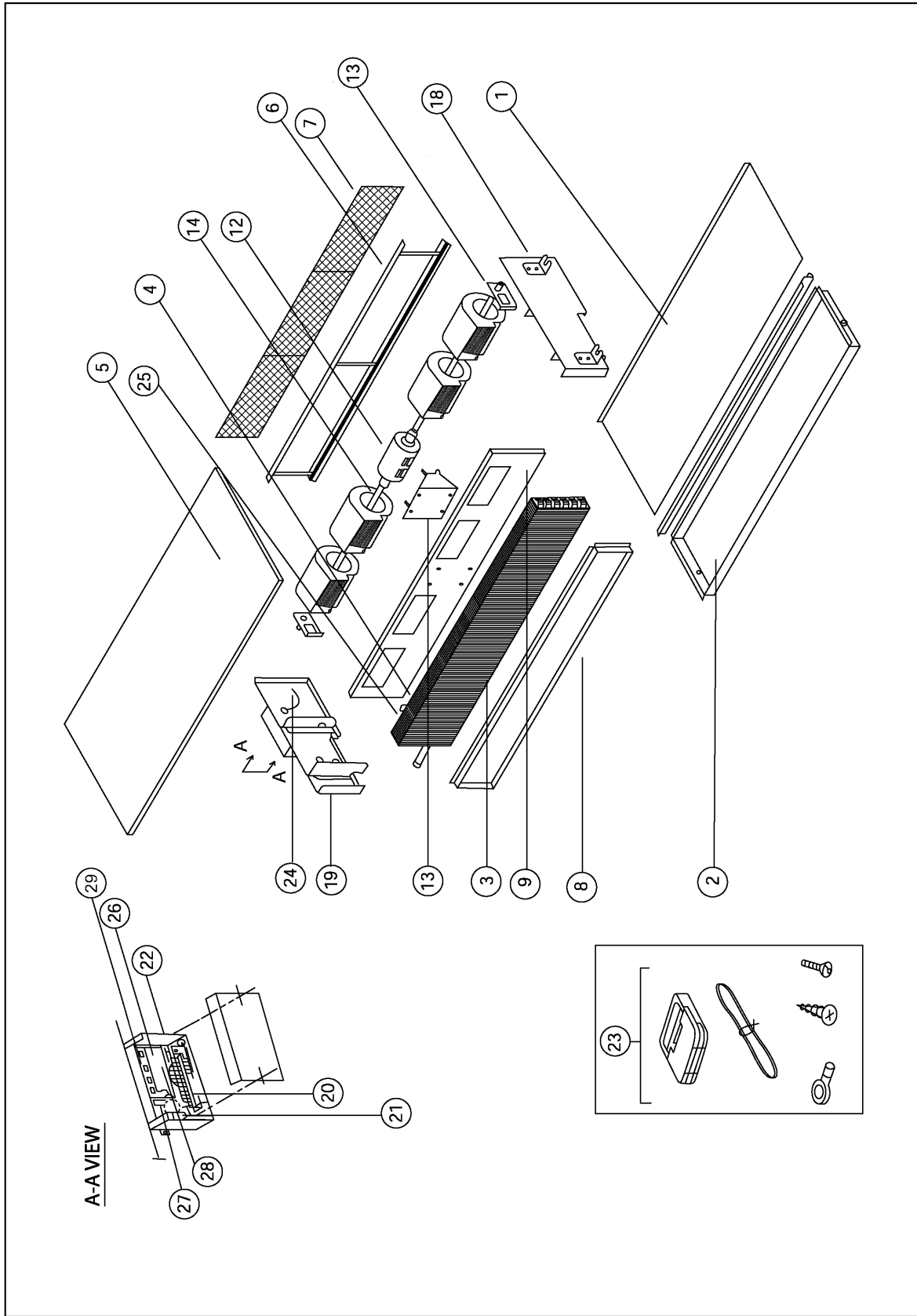

REF. NO.	PARTS NAME	PARTS NUMBER	QUANTITY PER UNIT		
			CS-A34BD3P	CS-A43BD3P	CS-A50BD3P
29	Wire Harness Ass'y IHA	P46-T04000	1	1	1

All parts are supplied from Taiwan (Tamaco).