

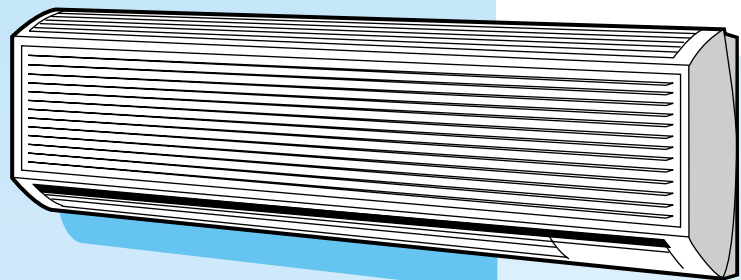

42 HWX / 42 HQX

42HWX/42HQX
06 - 08 - 10 - 12

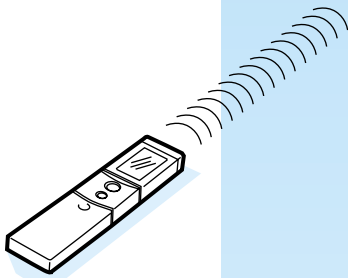
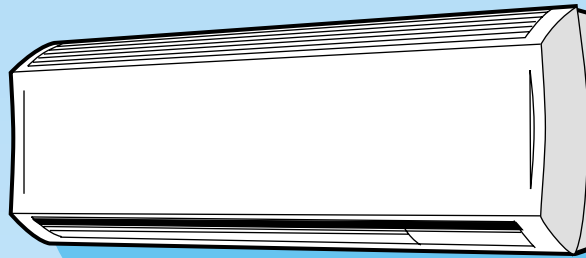

42HWX 18 - 24

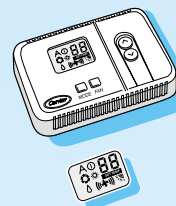
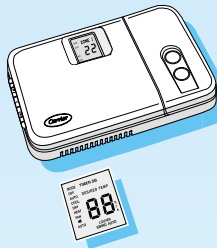
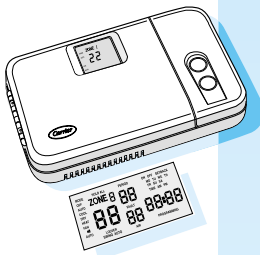

OWNER'S MANUAL

42 HWX / HQX

Split system “HI-Wall” indoor unit

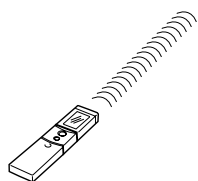

IR Remote Control

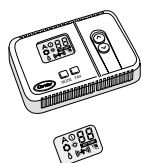

“Room Controller”



“Group Controller”

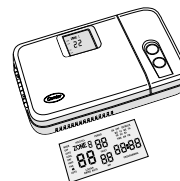

“Zone Manager”

The unit can be used with infrared Remote Control, with the Carrier “Room Controller” or “Group Controller” remote control. Some units can be used also with the Carrier “Zone Manager” remote control. Infrared control instructions are contained in the present manual. Remote controls instructions are contained in the relevant manuals.

The installation instructions for both the indoor and the outdoor unit are given in the manuals for each unit.

Contents

	Page
General information	2
System description	3
Infrared remote controller	4
Display of selected functions	5
Unit protection devices	5
Unit warning lights and controls	6
Periodical checks	6
Use of the remote controller	7/8
Optimum comfort and lowest consumption	9
Correct cleaning	9
Before a long shutdown period	9
Troubleshooting	10

42 HWX / HQX

General information

Unit operation and maintenance

Read this instruction manual thoroughly before using the unit.

- **This unit complies with low-voltage (EEC/73/23) and electro-magnetic compatibility (EEC/89/336) directives.**
- Check that the electrical mains supply has been connected to the outdoor unit (for sizes 18, 24).
- Check that voltage and frequency of the mains power supply are those required for the unit; power available must be adequate to operate any other possible appliances connected to the same line.
- Keep all operation and maintenance manuals carefully and deliver them to the next owner when the unit is passed on.
- Check that all current national safety code requirements have been followed for the installation.
In particular **ensure that a properly sized and connected ground wire is in place.**
- Use the unit only for factory approved applications: the unit cannot be used in laundry premises.
- Do not use damaged equipment. In case of a malfunction turn the unit off and disconnect mains supply.
- Disconnect the electrical mains supply prior to any maintenance operations or prior to handling any internal unit parts.
- Manufacturer declines any liability for damage resulting from modifications or errors in the electrical or refrigerant connections, made during the installation, or from the improper use of this equipment. This will void the unit warranty immediately.
- Failure to observe electrical safety codes may cause a fire hazard in case of short circuits.
- This unit will only work safely and correctly, if installed and tested by qualified personnel.
- Do not open the electronic remote controller to avoid possible damage. In case of malfunction contact a qualified service engineer.
- This unit contains rotating equipment (fan). Ensure that this is out of reach for children.
- Be conscious of the room temperature and general comfort, particularly when this units is used near children, senior or handicapped people.
- For correct use, the air conditioner must operate within the temperature limits indicated in the table "Operating Limits" included in the outdoor unit installation manual.
Incorrect use of the unit outside these limits may cause malfunction and dripping water.

- Inspect equipment for damage due to improper transportation or handling: In case of damage file an immediate claim with the shipping company.
- This equipment contains ozone depleting substances. Maintenance of the refrigerant circuit must only be carried out by qualified personnel.
- **All of the manufacturing and packaging materials used for your new appliance are compatible with the environment and can be recycled.**
- Dispose of the packaging material in accordance with local requirements.
- This equipment contains coolant that must be disposed of in a proper manner. When disposing of the unit after its operational life, remove it carefully. The unit must then be delivered to an appropriate disposal center or to the original equipment dealer, for proper environmentally friendly disposal.
- Controller batteries contain polluting elements. When exhausted, they must be disposed of in accordance with local requirements.

WARNING:

Do not switch off the split system by disconnecting the electric power supply. The unit must always be switched off using the remote control.

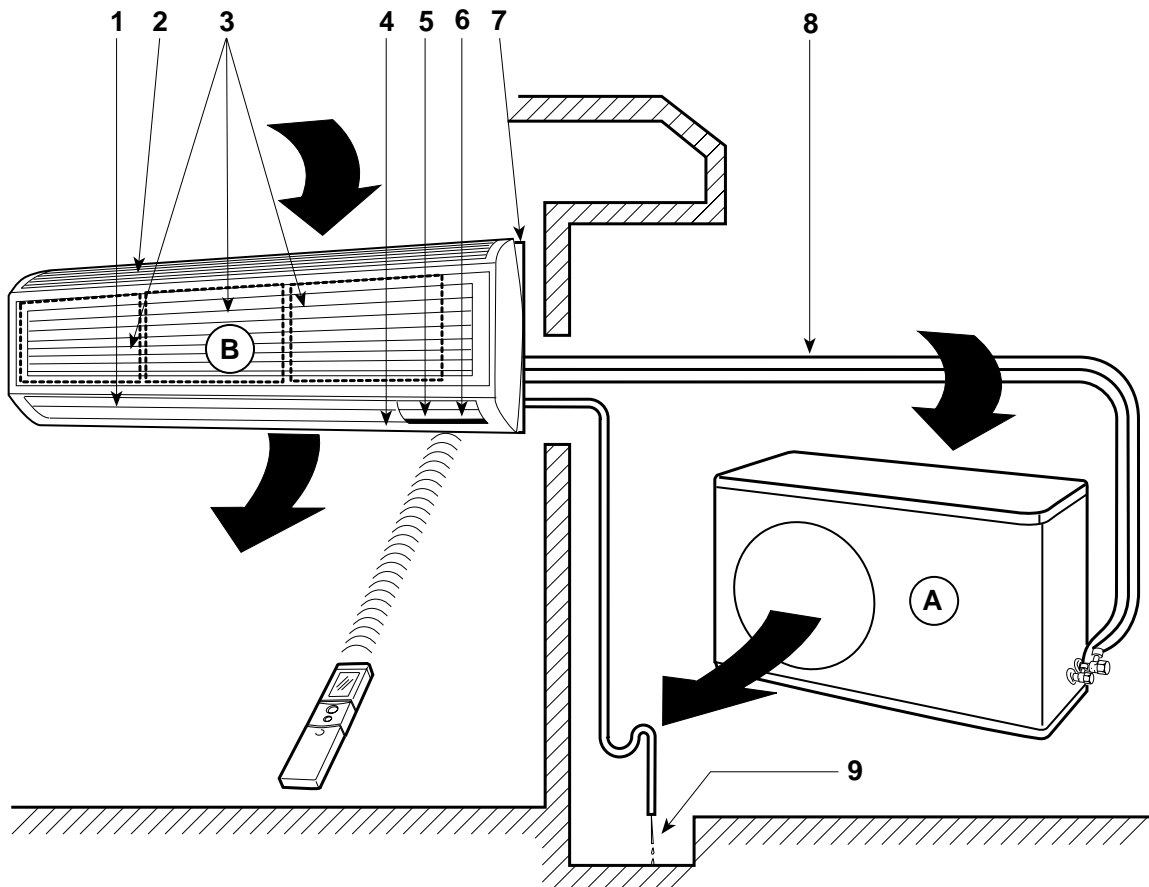
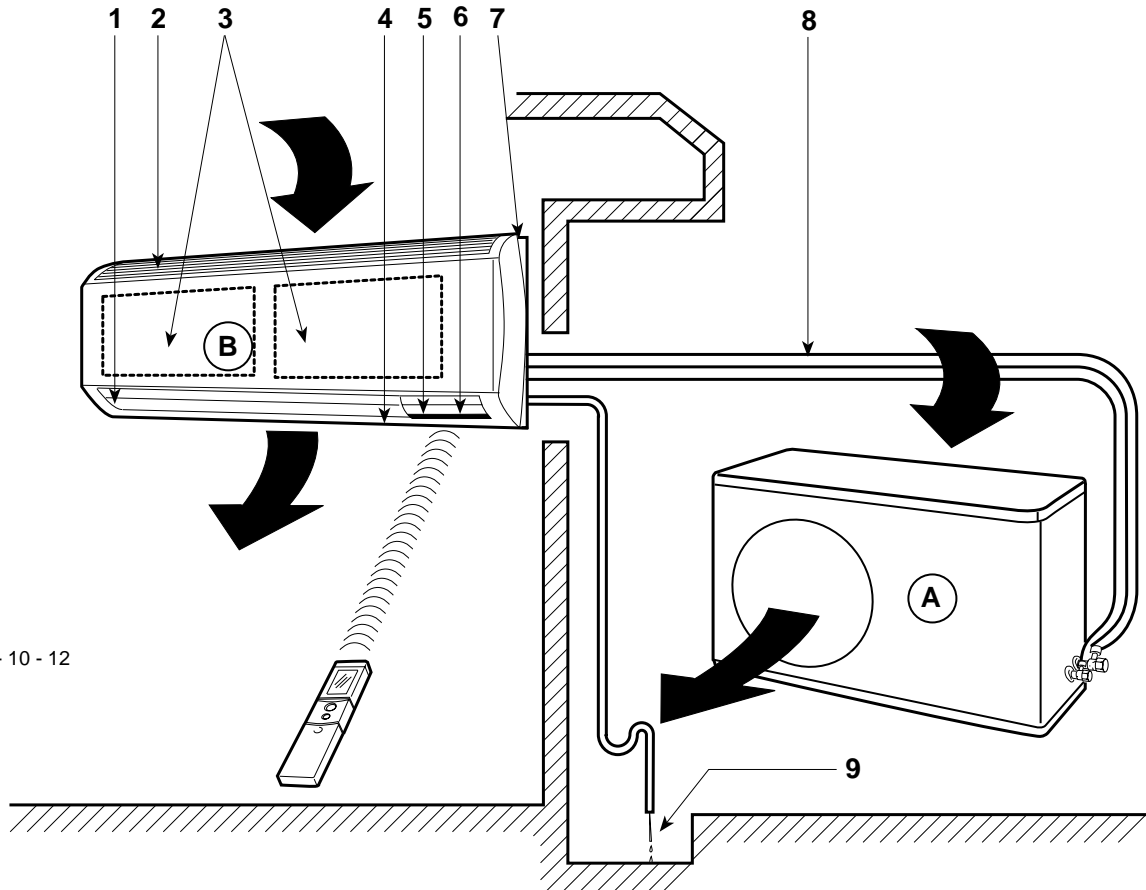

A. Outdoor unit
B. Indoor unit

1. Automatic swinging louver
2. Air return
3. Air filters

4. Air outlet
5. Indicators of unit operating status
6. Receiver of signals from remote controller

7. Characteristics nameplate
8. Interconnecting tubing
9. Condensate drain

42 HWX / HQX

Infrared remote controller

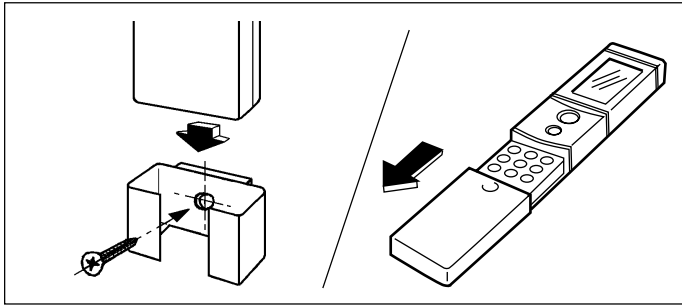

Fix to the wall the remote control holder using the screw.

The remote controller operates with two 1.5 V non re-chargeable batteries, type IEC LR03.
A fading display and reduced controller operating range indicate that the batteries are exhausted.

How to insert batteries:

Open sliding cover.

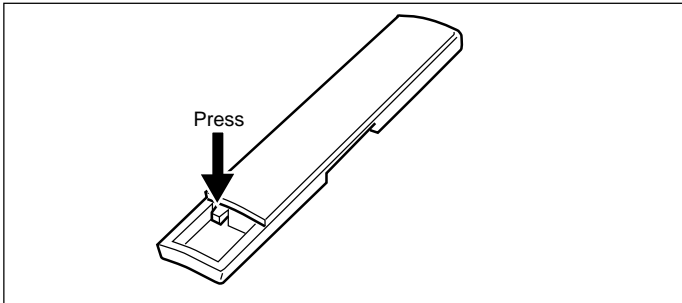

Remove the cover by pressing on the plastic catch at the rear of the controller.

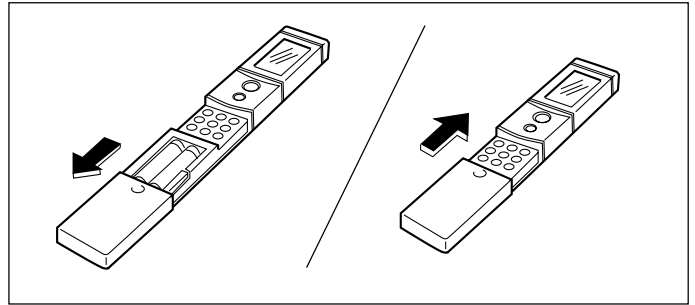

Insert batteries paying attention to the correct polarity indicated in the battery compartment; replace cover.

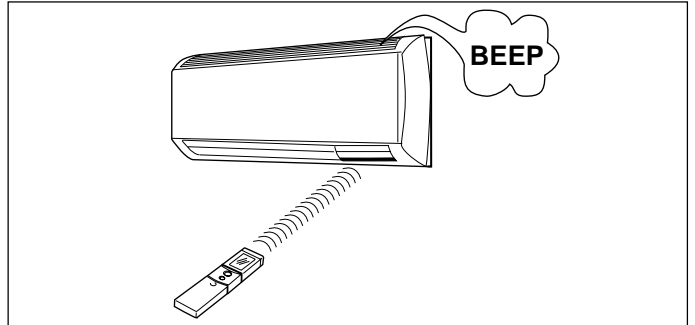

The maximum operating range for the remote controller is approx. 6 m. No obstructions such as curtains or plants should be between controller and unit. Direct sun on the unit receiver may interfere with good signalreception.

The controller must be directed toward the unit receiver when pressing the buttons of the desired functions. An acoustical acknowledgement sound (beep) will indicate that signal has been received. If the signal has not been received, renewed transmission is necessary by pressing any of the buttons E, F, L or J situated under the sliding cover. After the acknowledgment (beep), check the function displayed on the controller readout and adjust or modify the selection made, if necessary. During signal transmission symbol 1 ▲ will appear on the display (see next page). When symbol 1 ▲ is lit it is not possible to send other signals. A new signal can be sent only after symbol 1 ▲ has disappeared.

A. Display readout

B. On/Off button

C. Timer mode On/Off button

D. Mode selection button

E. Increase temperature button

F. Decrease temperature button

G. Timer program selection button

H. Set clock or timer hour button (Up)

I. Set clock or timer hour button (Down)

J. Fan speed selection button

K. Night mode button

L. Function not enabled

M. Clock set button

A. Display readout

B. On/Off button

C. Timer mode On/Off button

D. Mode selection button

E. Increase temperature button

F. Decrease temperature button

G. Timer program selection button

H. Set clock or timer hour button (Up)

I. Set clock or timer hour button (Down)

J. Fan speed selection button

K. Night mode button

L. Function not enabled

M. Clock set button

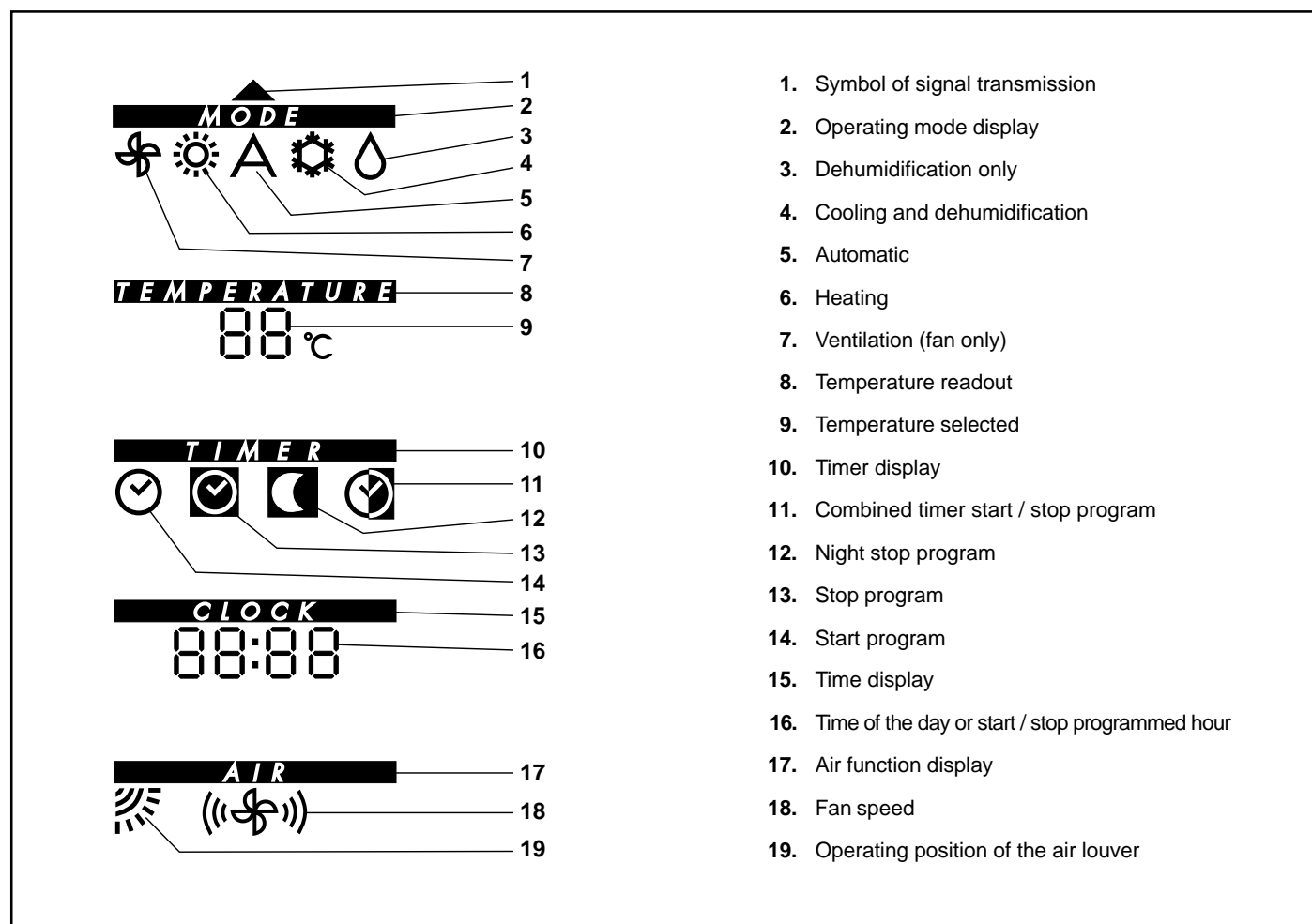
Table I: Unit protection devices ⁽¹⁾

Type of protection	Effect of protection	Operation mode	When on
Cold draft prevention	Indoor fan off or operating at speed lower than selected.	Heating in heat pump mode	At unit start and during operation
Defrost cycle	Indoor fan off or operating at speed lower than selected.	Heating in heat pump mode	During unit operation
Against freeze-up of cooling coil	Compressor off	Cooling	During unit operation
Against frequent compressor cycling	Compressor off	Cooling or heat pump	At unit start
On electric heaters	Fan will stop for 30 sec. after unit is turned off.	Electric heating	At unit stop

(1) In some temporary operating conditions (red indicator light on the indoor unit lit) the fan and the louver will not be in the selected position. It is not possible to change the position until the red indicator light goes off. When this happens, the fan louver automatically return to the position initially selected.

WARNING:

(models with electric heater):

If the manual thermostat trips the circuit, contact your local Assistance centre.

During heat pump operation unit will undergo several defrost cycles to eliminate ice that might possibly collect on the outdoor unit in very low ambient temperatures. In these cycles, fan speed will automatically reduce and cannot be varied until defrost cycle is completed.

42 HWX / HQX

Unit warning lights and controls

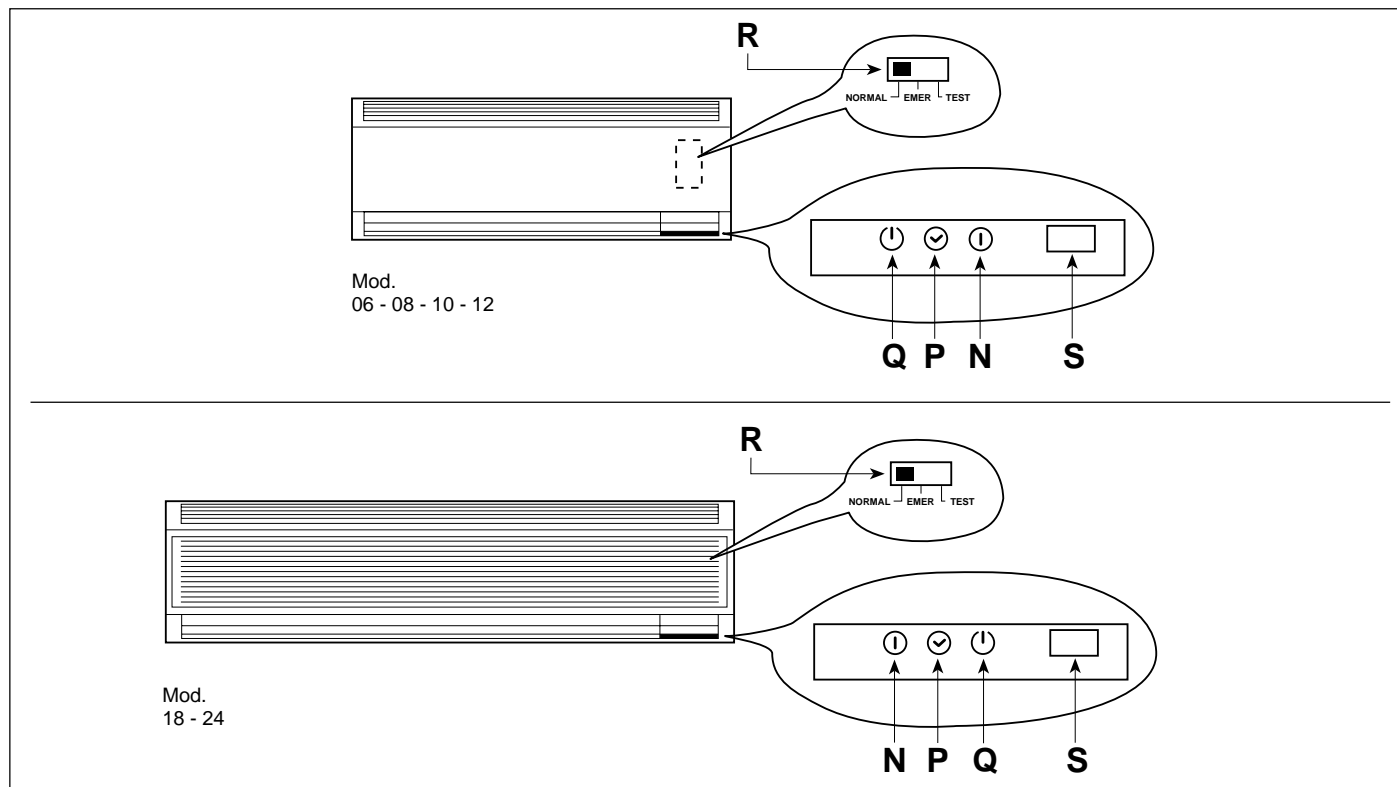

N **Green indicator:**
unit ON - unit OFF when not lit.

P **Yellow indicator:**
timer on, when lit.

Q **Red indicator:**
When lit, one of the equipment protections is in operation.

R **Operation switch:**
Three position switch for “normal”, “emergency” or “test” operation.

“Normal”: switch position for unit standard operation.

“Emergency”: put switch in this position if you want to start the unit and the infrared remote control does not work (e.g. - exhausted batteries) or is lost.
With the switch in this position unit will keep the room temperature at 23°C at the following conditions:

- Fan speed: medium.
- Timer mode: disabled.

During emergency operation the unit cannot receive signals from remote controller. After the controller operation has been restored, reset the switch to the “Normal” position.

“Test” position: this position should only be used by the installer or by service personnel. During “test” the unit will run in the cooling mode for 30 minutes. This can be switched off by pushing any button of the remote controller.

S **Signal receiver from remote controller.**

Notes:

- When indicator N flashes, there is a unit malfunction.
- When indicator P flashes, the power supply has been turned off; this indicator is lit only when the timer mode has been activated.
- When indicator Q is lit, some unit protection has been tripped.
- Table I shows protection devices included in the unit. An activated protection device is not a sign of unit or system malfunctioning. After a certain time (differs for each protection) the air conditioner will automatically return to normal operation.



Table II: Periodical checks

Indoor unit
Clean air filter Clean drain pipe Change controller batteries
Outdoor unit
Clean outdoor coil from outside Clean outdoor coil from inside Blow air over electric parts Check electric connections tightening Clean fan wheel Check fan tightening Clean drain pan



For correct maintenance of the air conditioner, contact an authorized service centre.

Start/stop (button B)



When the air conditioner is not in operation, the controller readout will display the time of day only (in case other symbols are lit, turn controller off by pressing button B .



Press button B  to start the air conditioner; indicator N  on the unit will appear and be illuminated.

All selected and memorized functions will light up and appear; the unit will operate according to the functions selected.

If the unit does not acknowledge the starting signal by emitting a sound ("beep") and indicator N  does not light up, it is necessary to turn the controller off by pressing button B  and then repeat the operation.

Press button B  to stop the air conditioner. All indicators on the unit will go out, and controller will display only the current time.

If the unit does not stop, turn the controller on (by pressing button B ) and repeat the operation. In some special operating conditions the fan will continue to run for 30 sec. after the unit stops; the indicator Q  on the unit will lighten.

If button B  (air conditioner starting) is pressed too soon after a stop, the compressor will not start for 3 minutes due to the inherent protection against frequent compressor cycling; in this case indicator Q  on the unit will also light up.

The unit will only emit a "beep", when the signals are received correctly.

Timer mode on/off (button C)

Press this button when you want the air conditioner to operate in the timer mode according to the time programs selected with button G .

When this function is on, indicator P  on the unit is lit.

After a power failure, indicator P  will flash and the unit will run in the last operating condition before the power cut.

Power failures will deactivate the Timer mode: to reactivate the Timer mode, press button C  twice.

Selection of the operating mode (button D)

With this button the operating mode of the air conditioner can be selected. Different options are available depending on the unit model. By repeatedly pressing this button the available modes will be selected in sequence and the relevant symbols will appear on the display, while the unit will acknowledge signal receipt with a confirming beep.

Symbol on display

 Cooling with dehumidification.

 Heating (where available).

 Automatic mode.
The air conditioner will automatically switch from heating (where available) to cooling and vice versa in order to maintain the selected temperature.



 Dehumidification only.
The air conditioner extracts moisture from the air without sensibly changing the room temperature.

 Ventilation (fan only)

Setting desired temperature

 UP
(button E)

 DOWN
(button F)

Pressing the UP (E ) and DOWN (F ) buttons will increase or decrease the temperature set from the previously set value. The unit will confirm signal receipt with a beep, and the value of the set temperature on the display will change accordingly.

The temperature can be set between 18°C and 29°C at 1 degree intervals.



In the cooling mode, if the temperature selected is higher than the room temperature the unit will not start; the same applies for the heating mode, if the selected temperature is lower than the room temperature.

Setting the timer programs (button G)

By pressing button G  it is possible to choose one of the following programs in sequence:

Symbol on display

No symbol Continuous operation
(timer off)

 Start time program
 Stop time program



 Combined program: unit will automatically cycle on and off as programmed



Set start time

Press button G  until the symbol indicating unit start program will appear on display under the word TIMER.

- The time appearing on display shows the starting hour previously programmed:



00:00

- You can set your personalized new start time by pressing buttons H  and I  until the desired time appears. Each press of the button will change the time up or down by 15 min. between 0:00 and 23:45.

Press button C  to confirm your selection: indicator P  on the unit will light up and the air conditioner is ready to start at the selected time.

If the unit is in operation when you send your confirmation by pressing button C , it will turn off and restart at the time now programmed.

Set stop time





Press button G  until the symbol indicating unit stop program appears on the display under the word TIMER. The time appearing on display shows the stop time previously programmed; you can now set your personalized new stop time by proceeding as for the start time. If the unit is turned off when you send your program confirmation by pressing button C , it will start up, and then turn off at the time now programmed.

42 HWX / HQX



Use of the remote controller

Set combined program

The combined program (a selection of a sequence of start and stop times) will start and stop the air conditioner daily at the programmed time without any action from the user. To program this function proceed as follows:

1. Press button G  until the symbol of the start time program shows on the display; set now your desired start time in the way indicated in the "set start time" section.
2. Press button G  again to show the symbol for the stop time program and set your desired stop time.
3. Press button G  repeatedly, until the symbol for the combined program appears; together with this symbol, the symbols for the start and stop programs appear alternatively along with the respective programmed times.
4. To confirm the program, press button C . Indicator P  on the unit will light up.



If the programmed times for start and stop coincide, the combined operation mode will not work.

It is possible to cancel the TIMER operation mode at any time by pressing button C : indicator P  on the unit will turn off, and the indication of the timer mode will disappear from display on the controller. The unit will store the mode in which was operating at that time: on if it was in operation, on if it was turned off.

When the timer mode is on (unit indicator P  lit) the controller will always display the symbol relevant to the current timer program; the time shown is the current time of day.

When only one of the two programs has been selected, i.e. the start time or the stop time, unit will remain in the selected operating mode (on or off) after having turned on or off at the selected time.





To change the operating mode, it is necessary to manually start or stop the unit or select a new program by pressing button C .

In case of a power failure during timer mode operation, the unit will restart, when the power is restored and return to the last operating position before the power cut: unit indicator P  will flash to show that the Timer mode is off. To reactivate the timer mode, press button C  twice.



Time adjustment (buttons H and I)







To set the time for the timer programs selected with button G , press the buttons H  and I . Buttons H  and I  also serve to adjust the time of day on the display under the word CLOCK.



Selecting the fan speed (button J)

The fan speed can be selected by pressing button J .

Symbol on display

-  Low speed
(for night operation)
-  Medium speed
-  High speed
(at starting, to reach temperature)
-  Automatic
(Fan speed will automatically switch to the value required for optimum comfort).
When this function is activated, the dotted symbols will flash.



Night stop (button K)

This function optimizes comfort at night with regard to human metabolism variations.

One hour after activation of this function, the temperature set in cooling will increase by 1°C, or decrease by 1°C if in heating, up to 2°C in two hours. After 5 hours the unit will stop completely.

The system will operate at the low fan speed to minimize sound level. When activating this function, the controller will show the time when the air conditioner will completely stop for a few seconds. Press button C  to deactivate the function.





Selecting direction of air flow louver (button L)

The air flow direction can be adjusted to optimize air distribution in the room. Press button L  repeatedly to choose one of the following positions:

Symbol on display

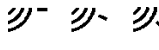

-  Automatic
Air direction will be set automatically.

Symbol on display

-  6 positions can be chosen.
The louver can be set to one of 6 different air flow directions.
-  The choice "Automatic" is recommended for cooling or dehumidification modes to avoid condensation on the louver resulting in dripping water.
-  Swing
Louver will continuously swing downward and upward to obtain an optimal even air distribution in the room.

Adjusting clock time (button M)

To adjust clock time, put the controller in the ON position by pressing button B  after having positioned the batteries. The following procedure will allow adjustment of the clock time:

- Gently press the recessed button at the right corner of the controller battery compartment with a pointed tool (e.g. a pencil point): the hour figures will flash.
Use buttons H  and I  to adjust their value to the correct time of day.
- Press the recessed button a second time and the minute figures will flash. Adjust them to the correct value in the same way.
- Pressing the recessed button a third time will activate the clock function.

42 HWX / HQX Optimum comfort and lowest consumption - correct cleaning - before a long shutdown period

Optimum comfort and lowest consumption

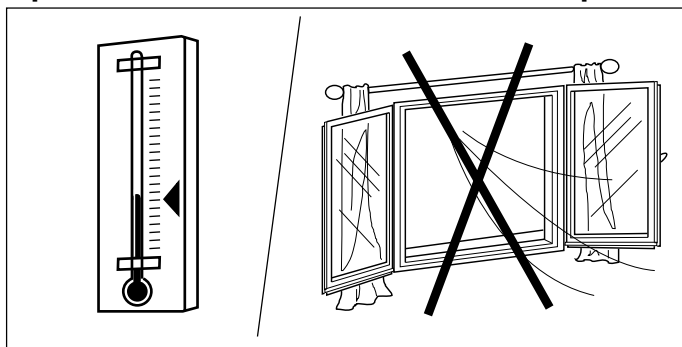

Keep room temperature to comfort levels.
Do not open doors and windows more frequently than necessary.

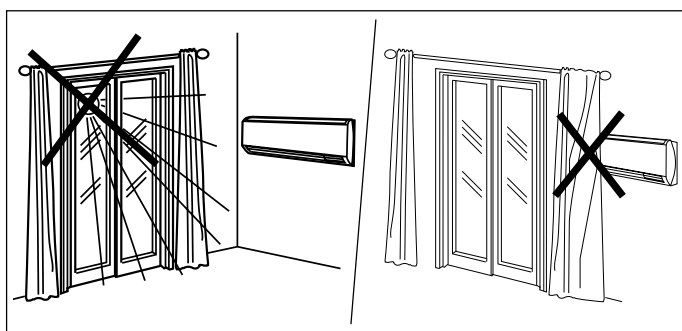

When in cooling, avoid direct sun in the room: if possible, shut curtains or shades.
Do not obstruct the air intake or outlet of the unit. Obstructions will cause a reduction of the air quantity and the conditioning effect, resulting in a unit malfunction.

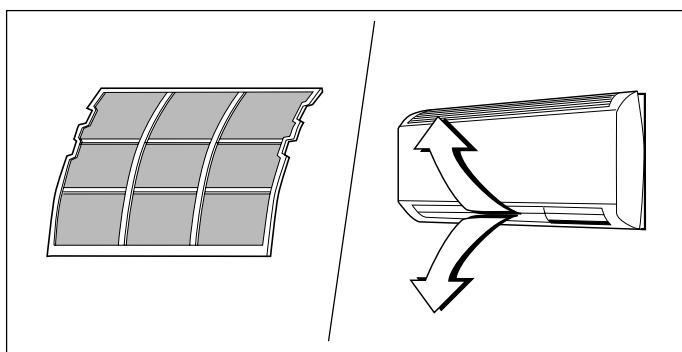

Ensure that the air filters are clean.
Ensure that the air distribution in the room is uniform by properly adjusting the air flow direction.

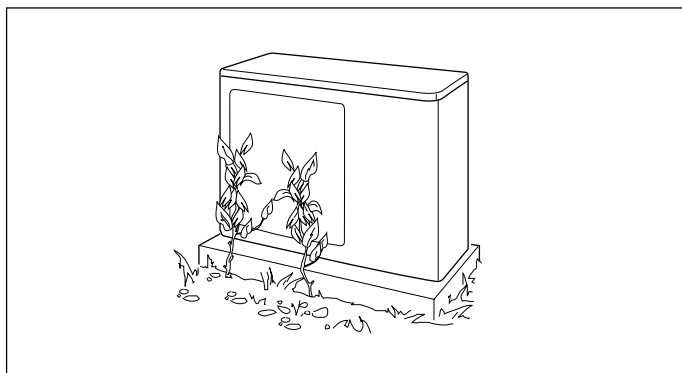

Occasionally clean the area around the outdoor (leaves etc.) to avoid reduced air circulation.

Correct cleaning

Turn the unit off and switch the mains supply off.

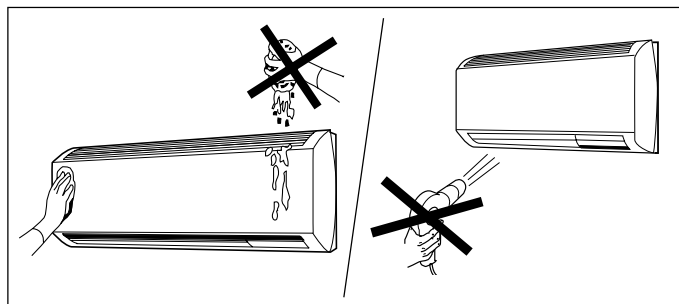

Use only a clean, damp and soapy cloth.
Do not pour any liquids on the unit.
Do not use flammable liquids, solvents or abrasive powders.

Before a long shutdown period

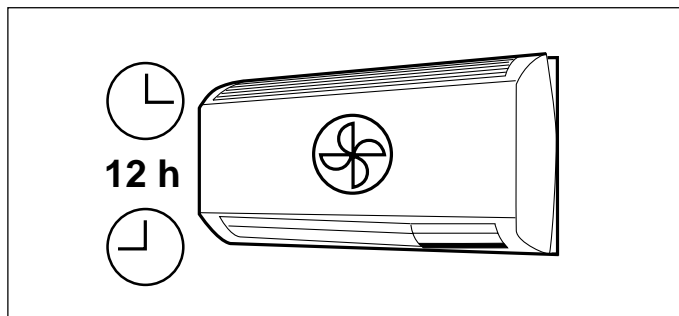

Make filters cleaned and reposition them in the unit.
Keep the unit in operation for half a day in the ventilation (fan only) mode in order to dry all its internal parts.

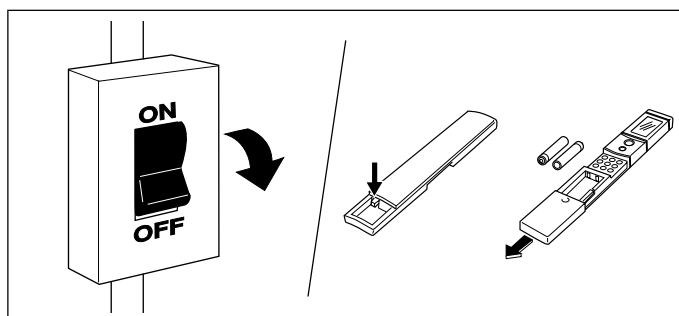

Switch electric mains supply off.
Take batteries out of the controller.

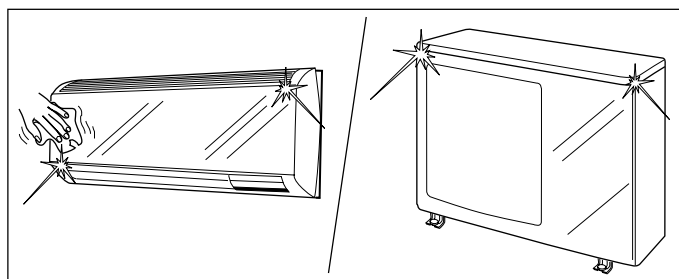

Clean indoor and outdoor units.

42 HWX / HQX

Troubleshooting

After batteries have been placed into the controller, the display is not lit:

- Batteries are exhausted or have the wrong polarity; replace batteries or check polarity.
-

When pressing the recessed clock adjustment button, hour figures on display do not flash:

- Recessed button has not been pressed correctly; press with a round point, avoid exerting strong pressure.
-

When pressing any button all symbols appear on display:

- Recessed button for time setting is blocked due to excessive pressure during use. Controller has been irreversibly damaged; replace with a new one.
-

When pressing start button, unit does not start and does not acknowledge signal with a beep:

- Main is switched OFF, switch it to ON.
 - Controller batteries are exhausted; replace.
 - Controller has not been pointed correctly to the unit receiver; turn controller off and repeat the operation in the correct direction.
 - There are obstacles (curtains, walls, etc.) between the controller and the unit; repeat the operation after having removed the obstacles.
 - Receiver on unit or the remote controller are under intense sun radiation; avoid direct sun on the unit, shut curtains or shades.
 - Signal transmission is obstructed by severe interference by electromagnetic field; avoid sending signals when computers or household appliances (food processors, coffee grinders, etc.) are operating close by. Cellular or cordless telephones may also interfere with the control.
-

When pressing stop button unit does not turn off and does not acknowledge signal with a beep:

- Controller batteries are exhausted; replace.
 - Controller has not been pointed correctly to the unit receiver; turn controller off and repeat the operation in the correct direction.
 - There are obstacles (curtains, walls, etc.) between the controller and the unit; repeat the operation after having removed the obstacles.
 - Receiver on unit or the remote controller are under intense sun radiation; avoid direct sun on the unit, shut curtains or shades.
 - Signal transmission is obstructed by severe interference by electromagnetic field; avoid sending signals when computers or household appliances (food processors, coffee grinders, etc.) are operating close by. Cellular or cordless telephones may also interfere with the control.
-



When pressing stop button the unit acknowledges signal receipt with a beep, but fan will not stop and indicator Q  is on:

- Unit will stop after 30 sec.
-

When pressing any function button, controller shows the function requested on the display, but unit does not acknowledge signal receipt with a beep and does not carry out the function:

- Controller batteries are exhausted; replace.
 - Controller has not been pointed correctly to the unit receiver; turn controller off and repeat the operation in the correct direction.
 - There are obstacles (curtains, walls, etc.) between the controller and the unit; repeat the operation after having removed the obstacles.
 - Receiver on unit or the remote controller are under intense sun radiation; avoid direct sun on the unit, shut curtains or shades.
 - Signal transmission is obstructed by severe interference by electromagnetic field; avoid sending signals when computers or household appliances (food processors, coffee grinders, etc.) are operating close by. Cellular or cordless telephones may also interfere with the control.
-

When pressing any button display will not change:

- The triangle symbol  is on, as another signal is being transmitted; wait for signal  to disappear and repeat the operation.
-

Air conditioner will not start:

- Main supply switch is OFF; switch to ON.
 - Fuses on main switch are burnt out; replace fuses.
 - Wait for 3 minutes: protection against frequent compressor cycling is on if the symbol Q  is lit.
 - Selected temperature is higher than the room temperature (or lower in the heating mode).
-

Air conditioner is not supplying enough cooling (or heating):

- Air flow cannot circulate freely.
 - Dirty filters reduce air quantity circulating.
 - Doors and/or windows are open.
 - Fan speed has been set to 'low'.
 - Air flow direction is not correct.
 - Selected temperature is not correct.
-

A slight mist is emitted from the unit:

- A slight mist, coming out of the unit air outlet, can be sometimes noticed during cooling operation. This is due to the cool air coming into contact with the room air.
-

A slight whistling noise is heard when the air conditioner starts or stops:

- This is due to the refrigerant beginning to circulate or an adjustment of the refrigerant pressures.
-

N  indicator is flashing:

System malfunction.

Contact service organization after having made the following checks:

- Filters are clean.
 - Air circulation is not obstructed.
 - Outdoor unit coil is not obstructed with a severe reduction of air circulation.
-

Restart air conditioner after having corrected the faults.

Water vapour (mist) emanating from the outdoor unit:

- It is normal in heat pump operation, when defrost is automatically activated.
-

Unpleasant smells coming from the unit:

- Unpleasant smells can be caused by substances accumulated in the air filter. Stop unit and clean filters after switching mains supply off. Restart unit in the ventilation (fan only) mode and open windows to change room air.
-

Strange noises coming from the unit:

- Occasionally the unit can emit some strange short noises during operation or when it has stopped. These are generally due to the effect of temperature changes on the plastic parts.
-

Starting in heating mode for heat pump systems:

- If the unit starts at low ambient temperatures, it takes a little while to reach a comfortable room temperature. When the unit is started by the remote control, it emits a signal beep, but the louvre does not swing and the fan does not run until the operating temperature has been reached. During this period the Q  indicator light is on.
-

WARNING

(models with electric heater)

- If the manual thermostat trips the circuit, contact your local Carrier office.
-



Via R. Sanzio, 9 - 20058 Villasanta (MI) Italy - Tel. 039/3636.1

The manufacturer reserves the right to change any product specifications without notice.