3. Installation and Operating Instructions

3-1 Installation

* When selecting the area for installing the unit, be sure to obtain approval of the customer.

1. Make sure that you install the unit in an area that provides good ventilation.
The air conditioner must not be blocked by any obstacle affecting the air flow near the air inlet and air outlet.
2. Make sure that you install the unit in an area which can endure the weight and vibration of the unit.
3. Make sure that you install the unit away from heat or vapor.
4. Make sure that you install the unit in an area where the cooled air can be evenly spread in a room.
5. Make sure that you install the unit in an area away from TVs, audio units, cordless phones, fluorescent lighting fixtures and other electrical appliances.
(obtain a clearance of at least one meter)
6. Make sure that you install the unit in an area which provides easy drainage for condensed water.
7. Make sure that you install the unit in an area not exposed to rain or direct sunlight.
(Install a separate sunblind if exposed to direct sunlight.)
8. Do not install the unit in an area subjected to noise or vibration amplification which may affect your neighbor.
(Fix the unit firmly if mounted in a high place.)

Caution:

Do not use the air conditioner in such areas as a greasy area(including machine oil), saline area(sea side), or sulphuric area(hot spring). When using the air conditioner in these areas, special maintenance is required. Contact your local dealer or our service center for advice.

3-2 Function Description

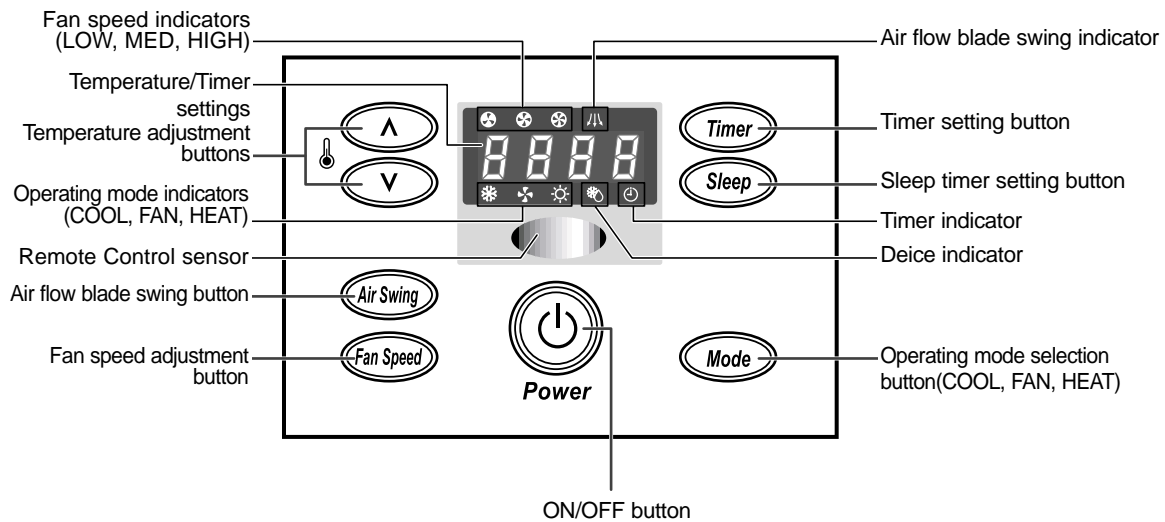

3-2-1 Cooling operation mode

The compressor is turned on and off according to the ambient temperature and set temperature.

- Compressor on and off control
 - Compressor on and off control according to the ambient temperature.
 - The compressor is turned off when ambient temperature = set temperature
 - The compressor is turned on when "ambient temperature = set temperature +1°C"
- Default value after power reset → set temperature = 24°C(75°F)
FAN SPEED = HIGH
- Set temperature indicating (setting) range : 1°C(1°F) interval from 18°C to 30°C(64°F to 86°F).

3-2-2 Heating operation mode

The compressor is turned on and off according to the ambient temperature and set temperature.

- Compressor on and off control
 - Compressor on and off control according to the ambient temperature.
 - The compressor is turned off when "ambient temperature = set temperature +1°C"
 - The compressor is turned on when "ambient temperature = set temperature -1°C"
- Default value after power reset → set temperature = 24°C(75°F)
FAN SPEED = HIGH
- Set temperature indicating (setting) range : 1°C(1°F) interval from 16°C to 30°C(61°F to 86°F).

3-2-3 Fan operation mode

- If "Fan operation mode" signal is received from remote or panel.
 - the compressor is immediately turned off and only fan motor is operated at set blowing speed.
 - it changes such as "HIGH → MED → LOW → HIGH" (if Fan speed is selected).
- The initial FAN speed is set to "HIGH".
- The set temperature can not be indicated and set.

3-2-4 Sleep operation mode

1. Enable to sleep operation only when cooling operation.
2. First, 7-SEG LED displays “SLEEP” while 15 second, Second, 7-SEG LED display “8Hr”
And, automatically SET OFF after operated while 8 Hour.
3. In sleep operation, setting Temperature rise 1°C after 1 Hour.
4. In ON TIMER operation, sleep operation is unavailable.

3-2-5 LED display indication in case of error detection

ERROR OPERATION	7-SEG LED DISPLAY
ROOM THERMISTOR (OPEN or SHORT)	E1 displayed
INDOOR PIPE THERMISTOR (OPEN or SHORT)	E5 displayed
OUTDOOR PIPE THERMISTOR (OPEN or SHORT)	E6 displayed

3-2-6 Panel key operation

Key name / Key discription	Key operational function	Key Type
POWER	Operation start and stop * First ON = operation start, second ON = operation stop * Continuous operation is not available.	MEMBRANE KEY PAD
Mode	Operation mode change * at every ON - Selected as "COOL → HEAT → FAN (Default=COOL) * If operation is OFF, it is considered as an invalid key. * Continuous operation is not available.	MEMBRANE KEY PAD
Fan speed	* At every ON → Selected as "HIGH → MED → LOW → HIGH"(DEFAULT=HIGH). * If operation is OFF, it is considered as an invalid key. * Continuous operation is not available.	MEMBRANE KEY PAD
Temperature (▲, ▼)	Currently displayed set temperature increase/decrease * At every pressing, the set temperature is changed by 1°C, (1°F) (Cooling operation.) (increase(▲) : 18°C → 19°C → ... → 29°C → 30°C), (64°F → 65°F → ... → 85°F → 86°F). (decrease(▼) : 24°C → 23°C → ... → 19°C → 18°C), (86°F → 84°F → ... → 65°F → 64°F). * At every pressing, the set temperature is changed by 1°C, (1°F) (Heating operation.) (increase(▲) : 16°C → 17°C → ... → 29°C → 30°C), (61°F → 65°F → ... → 85°F → 86°F). (decrease(▼) : 24°C → 23°C → ... → 17°C → 16°C), (86°F → 84°F → ... → 62°F → 61°F).	MEMBRANE KEY PAD

Key discription Key name	Key operational function	Key Type
<p>Temperature (▲, ▼)</p>	<ul style="list-style-type: none"> * In case of above situation, when "increase / decrease" key is pressed by remocon, warning sound is generated. * If operation is OFF, it is considered as an invalid key. * In case of "FAN" mode operation, it is considered as an invalid key. * Continuous operation is available. 	<p>MEMBRANE KEY PAD</p>
<p>Air swing</p>	<p>Air swing motor operation and stop.</p> <ul style="list-style-type: none"> * Once ON Air swing motor operation. Another ON Air swing motor stop. * Continuous operation is not available. * In case of operation stop, when the fan motor is turned off it is considered as an invalid key. 	<p>MEMBRANE KEY PAD</p>
<p>Timer (ON/OFF)</p>	<p>Setting the on/off timer.</p> <ul style="list-style-type: none"> * Can set "OFF TIMER HOUR" if set is operation. * Can set "ON TIMER HOUR" if set is not operation. * Once ON-standby setting TIMER : "- -" displayed. * In case of key pressing in status of standby setting ON/OFF TIMER. (--Hr -> 1Hr -> 2Hr -> ... -> 23Hr -> 24Hr) * In press TIMER key countinuosly operate such the lower part. (--Hr -> 1Hr -> 2Hr -> ... -> 24Hr -> --Hr) 	<p>MEMBRANE KEY PAD</p>
<p>Sleep</p>	<p>SLEEP mode on and off.</p> <ul style="list-style-type: none"> * Once ON = SLEEP mode on, Another ON = SLEEP mode off. <ul style="list-style-type: none"> • Continuous operation is not available. * In case of OFF TIMER mode, if press SLEEP mode then OFF TIMER Mode is canceled and SLEEP Mode operates. * SLEEP Mode is not available in ON TIMER and FAN Mode. * SLEEP Mode is available in cooling and heating operation mode. 	<p>MEMBRANE KEY PAD</p>

3-2-7 LED lamp operation specifications

LAMP name	Operations specifications
COOL (❄️)	The mode is set to "COOL" → ON Others → OFF
HEAT (☀️)	The mode is set to "HEAT" → ON Others → OFF
FAN (🌀)	The fan speed is set to "FAN" → ON Others → OFF
HIGH (🌀)	The fan speed is set to "HIGH" → ON Others → OFF
MED (🌀)	The fan speed is set to "MED" → ON Others → OFF
LOW (🌀)	The fan speed is set to "LOW" → ON Others → OFF
TIMER (⌚)	The mode is set to "TIMER" → ON Others → OFF
AIR SWING (↕️)	The mode is set to "Air Swing" → ON Others → OFF
DEICE (❄️)	Until the "DEICE" operation is completed during heating operation → ON Others → OFF
	In case of set temperature display → NO. (1) 7-SEG LED DISPLAY indicates temperature of the tens digit → NO. (2) 7-SEG LED DISPLAY indicates temperature of the units digit In case of time display → NO. (1) 7-SEG LED DISPLAY indicates time of the tens digit → NO. (2) 7-SEG LED DISPLAY indicates time of the units digit
	In case of set temperature display → NO. (3) 7-SEG LED DISPLAY indicates temperature unit(°) → NO. (4) 7-SEG LED DISPLAY indicates temperature unit(C), (F) In case of time display → NO. (3) 7-SEG LED DISPLAY indicates time unit(H) of the tens digit → NO. (4) 7-SEG LED DISPLAY indicates time unit(r) of the units digit
	First, 7-SEG LED DISPLAY "SLEEP" while 15 second, Second, 7-SEG LED DISPLAY "8Hr"

3-2-8 Resistor values table of “Room thermistor”, “Indoor pipe thermistor” and “Outdoor pipe thermistor” for each temperature

1. Room thermistor (SPEC : 103AT)

Temperature [°C]	THERMISTOR RESISTOR [Kohm]
70	2.229
69	2.296
68	2.365
67	2.437
66	2.512
65	2.589
64	2.669
63	2.752
62	2.838
61	2.928
60	3.021
59	3.116
58	3.216
57	3.319
56	3.426
55	3.537
54	3.652
53	3.772
52	3.897
51	4.026
50	4.161
49	4.300
48	4.444
47	4.594
46	4.749
45	4.912
44	5.080
43	5.256
42	5.439
41	5.630
40	5.828
39	6.033
38	6.246
37	6.468
36	6.699
35	6.941
34	7.192
33	7.455
32	7.729
31	8.015
30	8.313

Temperature [°C]	THERMISTOR RESISTOR [Kohm]
29	8.622
28	8.944
27	9.281
26	9.632
25	10.000
24	10.380
23	10.780
22	11.200
21	11.630
20	12.090
19	12.560
18	13.060
17	13.570
16	14.120
15	14.680
14	15.280
13	15.900
12	16.550
11	17.240
10	17.960
9	18.700
8	19.480
7	20.290
6	21.150
5	22.050
4	22.990
3	23.900
2	25.030
1	26.130
0	27.280
-1	28.470
-2	29.720
-3	31.040
-4	32.430
-5	33.890
-6	35.430
-7	37.050
-8	38.760
-9	40.560

2. "Indoor pipe Thermistor" and "Outdoor pipe Thermistor" (SPEC : 10KD)

Temperature [°C]	THERMISTOR RESISTOR [Kohm]
70	1.670
69	1.729
68	1.791
67	1.855
66	1.922
65	1.992
64	2.065
63	2.141
62	2.220
61	2.303
60	2.390
59	2.480
58	2.574
57	2.672
56	2.775
55	2.882
54	2.994
53	3.111
52	3.234
51	3.362
50	3.496
49	3.635
48	3.780
47	3.932
46	4.091
45	4.257
44	4.432
43	4.614
42	4.806
41	5.007
40	5.217
39	5.438
38	5.669
37	5.912
36	6.167
35	6.435
34	6.716
33	7.012
32	7.322
31	7.649
30	7.993

Temperature [°C]	THERMISTOR RESISTOR [Kohm]
29	8.354
28	8.734
27	9.135
26	9.556
25	10.00
24	10.46
23	10.94
22	11.45
21	11.99
20	12.55
19	13.15
18	13.78
17	14.44
16	15.14
15	15.88
14	16.66
13	17.48
12	18.36
11	19.28
10	20.25
9	21.28
8	22.38
7	23.54
6	24.76
5	26.06
4	27.44
3	28.90
2	30.45
1	32.10
0	33.85
-1	35.66
-2	37.59
-3	39.64
-4	41.82
-5	44.14
-6	46.60
-7	49.22
-8	52.01
-9	54.98
-10	58.14

3-2-9 About the safety devices

1. High temperature release : If temperature of the "indoor pipe thermistor" increases over the specified value during heating operation, following operation is carried out for safety of the equipment.

- ┌ A condition : temperature of "indoor pipe thermistor" is below 47°C
- ├ B condition : temperature of "indoor pipe thermistor" is between 58°C and 63°C
- └ C condition : temperature of "indoor pipe thermistor" is over 63°C

- 1) High temperature release operation OFF condition = A condition
 - > compressor ON (only in THERMO ON condition)
 - > fan motor speed = set fan speed and cool blowing inhibiting operation
- 2) High temperature release operation ON condition = B condition
 - > compressor ON
 - > fan motor speed = Only HIGH operation regardless of previous selection
- 3) High temperature release operation ON condition = C condition
 - > fan motor speed = set fan speed
 - > compressor OFF

2. Low temperature release : If temperature of the "indoor pipe thermistor" decreases below the specified value during cooling operation, following operation is carried out for safety of the equipment.

- ┌ A condition : temperature of "indoor pipe thermistor" is below -1°C for more than 6 minutes
- └ B condition : temperature of "indoor pipe thermistor" is over 5°C

- 1) Low temperature release ON condition = A condition
 - > compressor OFF
 - > fan motor "set fan speed"
- 2) Low temperature release OFF condition = B condition
 - > The compressor is turned on if ON condition is satisfied after comparing the ambient temperature with the set temperature
 - > fan motor "set fan speed"

[Detailed description]

- 1) If temperature of "indoor pipe thermistor" is below -1°C for more than 6 minutes, the fan motor continues to operate at the set fan speed and the compressor is turned off(Low temperature release operation)
- 2) If temperature of the "indoor pipe thermistor" increases over +5°C during low temperature release operation, normal operation is recovered
: compressor ON, fan motor set fan speed -> Low temperature release operation OFF
- 3) If temperature of "indoor pipe thermistor" increases over 0°C during counting 6 minutes below -1°C, the counter is reset.

3. Deicing operation : If temperature of the outdoor pipe thermistor decreases below the specified value during heating operation, following operation is carried out for safety of the equipment.

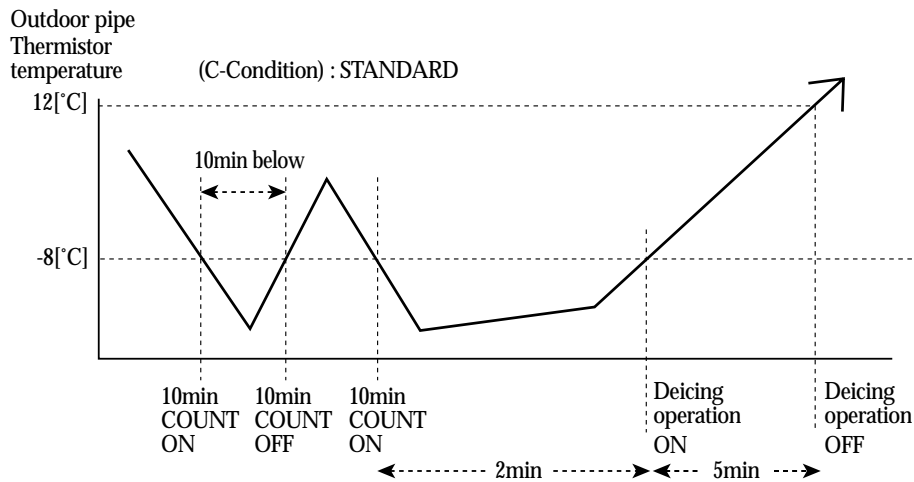
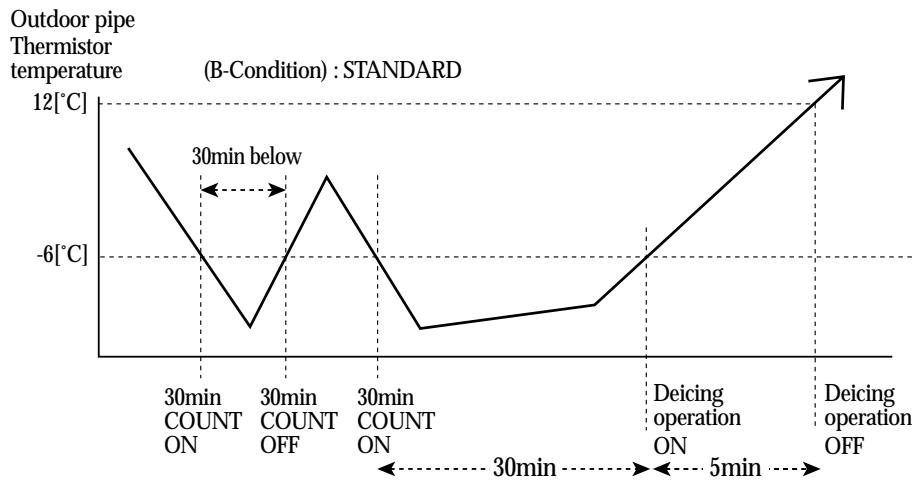
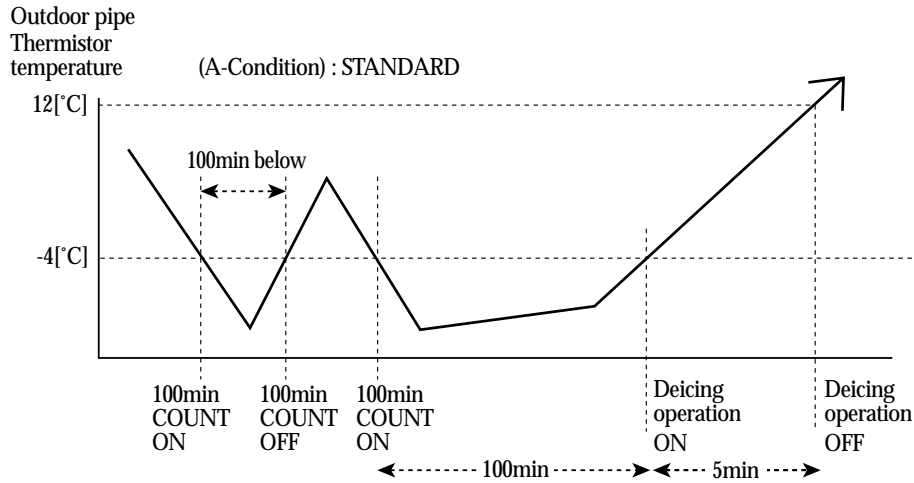

1) Deicing detecting condition

- If one of A, B and C conditions is satisfied, deicing operation is carried out.(AUBUC)
- If counting time is overlapped due to detection reference temperature change during counting of the deicing condition, deicing operation starts when the counting time is finished first.
- The maximum counting time is 100 minutes.
 - During deicing operation, the left and right swing motor is turned off and stops at the position before swing.
 - If operation is turned off during deicing operation, it is finished and the compressor is turned off.
 - > Deice lamp ON, fan motor OFF.

2) Display indication.

- The deice lamp is turned on additionally during deicing cycle.
- Only the deice lamp is turned off when deicing is finished.

3) In case of turning off during deicing operation.

- The compressor is turned off after finishing the deicing operation.
- The deice lamp is turned on during deicing cycle and is turned off when deicing is finished.

4) In case of changing mode to cooling operation during deicing operation.

- Cooling operation is carried out after carrying out deicing operation.
- After the compressor is turned off and 1 minutes is passed, it is restarted.

5) Load operation during deicing operation.

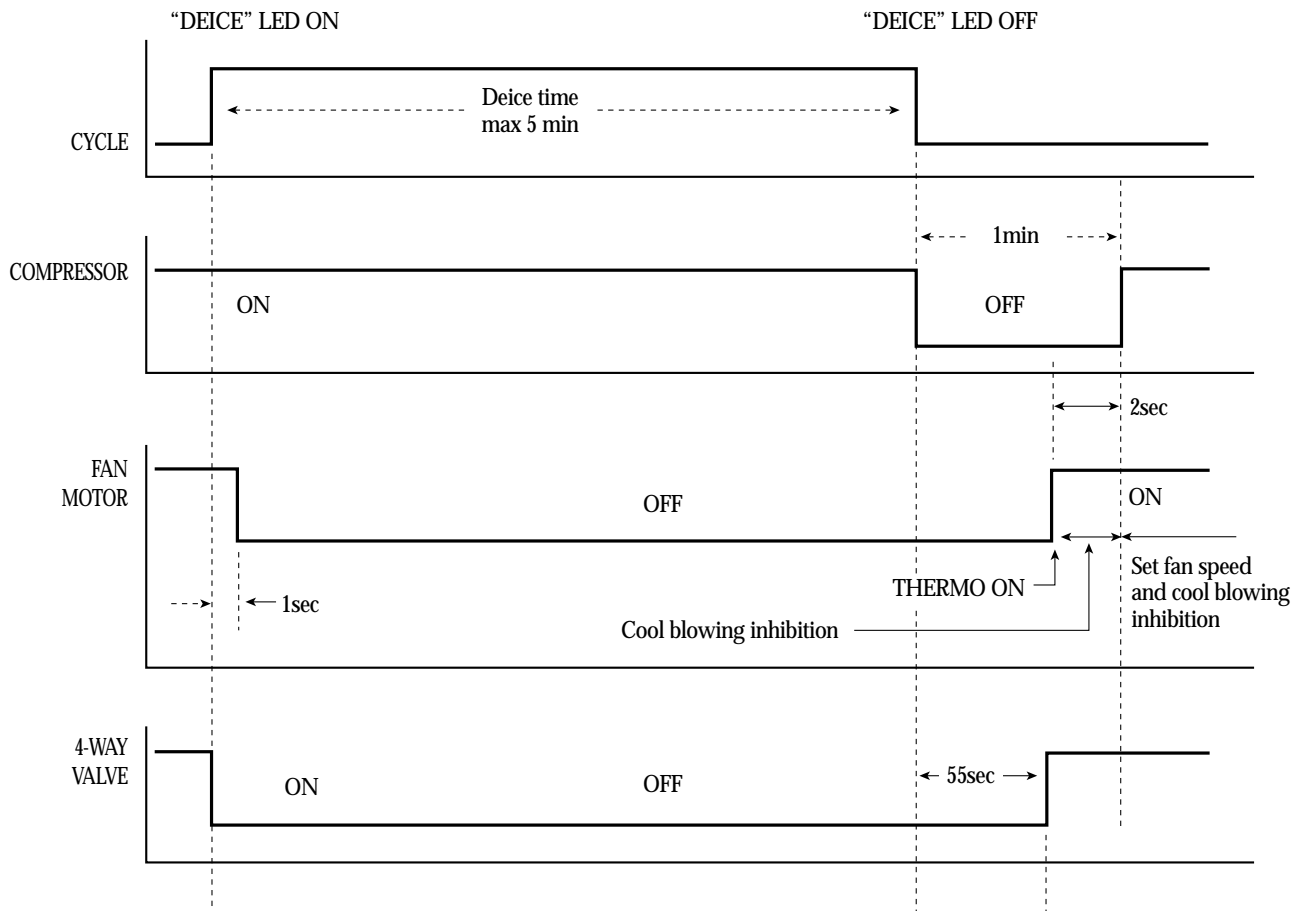

4. Cool blowing inhibiting control : In order to inhibit cool blowing during heating operation, the fan motor is operated when temperature of the "indoor pipe thermistor" is above the specified value.
- The fan motor speed is controlled according to the temperature of condition of the "indoor pipe thermistor".

< Compressor OFF -> Compressor ON >

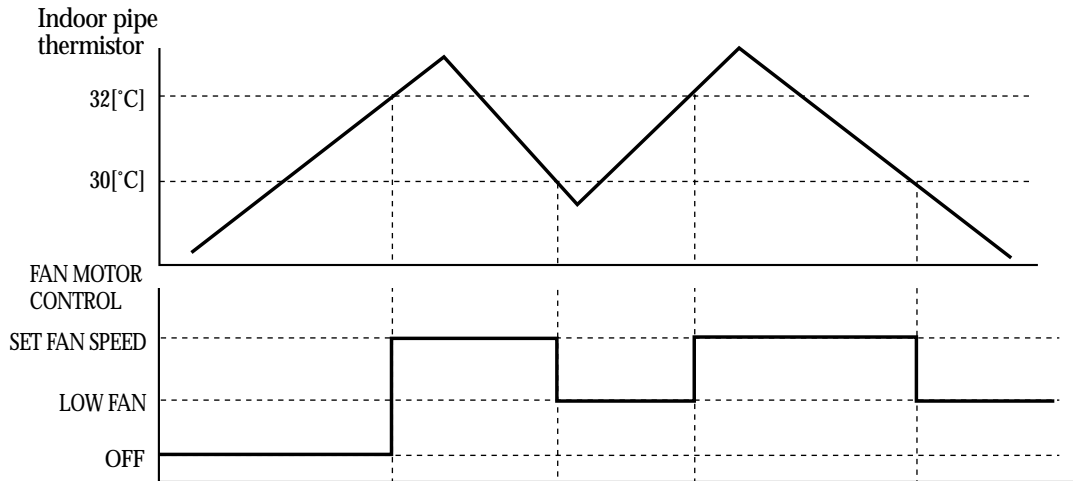

< Compressor ON -> Compressor OFF >

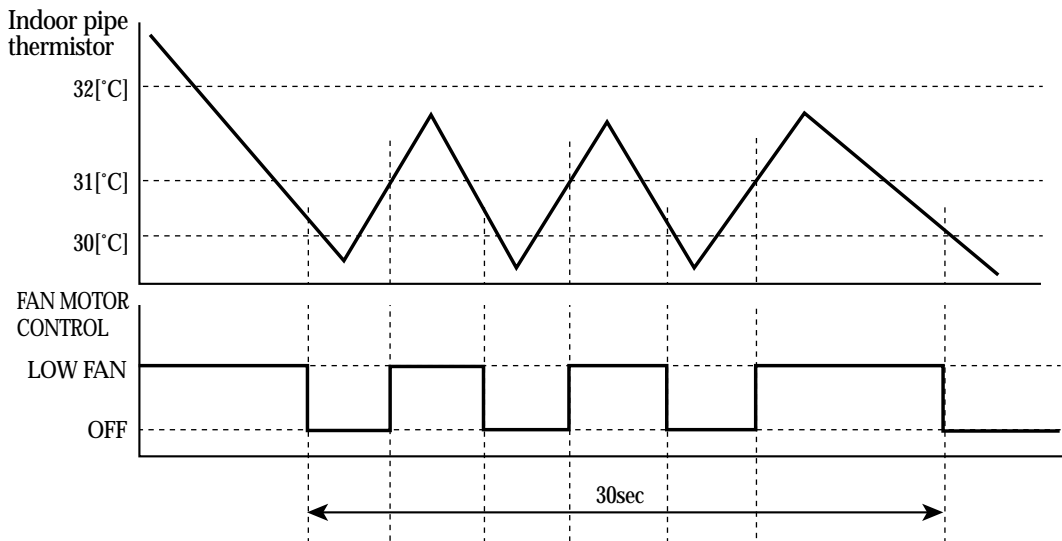

- 1) When the "indoor pipe thermistor" temperature is increasing
 "indoor pipe thermistor" temperature = below 32°C --> fan motor OFF
 "indoor pipe thermistor" temperature = over 32°C --> fan motor speed "set blower speed"
- 2) When the "indoor pipe thermistor" temperature is decreasing
 "indoor pipe thermistor" temperature = over 30°C --> fan motor speed "set blower speed"
 "indoor pipe thermistor" temperature = below 30°C --> fan motor speed "Low"
- 3) But if the compressor is operating, the fan motor is not turned off but is operated weakly even if the "indoor pipe thermistor" temperature decreases.

< Compressor ON -> Compressor OFF >

"indoor pipe thermistor" temperature = below 30°C --> fan motor speed "Low"

"indoor pipe thermistor" temperature = over 30°C --> fan motor OFF

30s is passed after compressor is turned off --> fan motor OFF

3-2-10 Compressor delayed operation and 4-way valve delayed operation

The compressor is turned on after 3 minutes from power resetting or compressor turning off during cooling or heating operation.

- 1) The compressor can be turned on after "3 minutes delay" from power resetting or compressor turning off.
- 2) The 4 way valve is turned off/on after "2 minutes and 55 seconds delay" in the on/off condition.
(during heating operation)
- 3) The operation is stopped after "2 minutes and 55 seconds delay" in the off condition when the 4 way valve is turned on.