

2. Installation

2-1 Wiring diagram

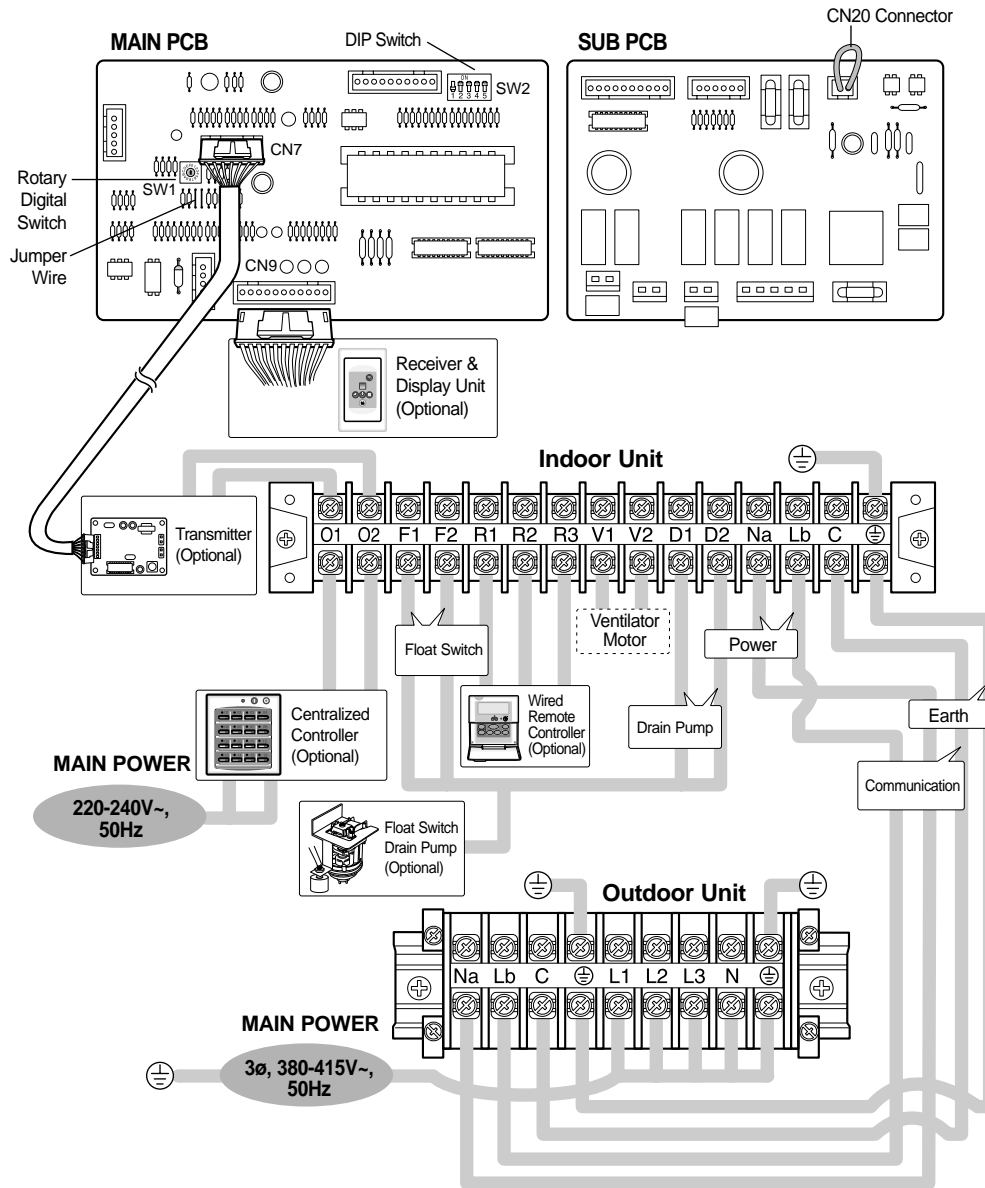

Cable Specifications

The following electrical characteristics must be respected.

MODEL	ADH4400G / DH44ZA1(A2)	Note
Power	3Ø, 380-415V~, 50Hz	<ul style="list-style-type: none"> ◆ The power cables are not supplied with the air conditioner. The user should purchase them separately. ◆ When connecting the cables to the main power, you should connect each cable(L1, L2 & L3) properly.
Sub switch	30A	
Fuse	30A	
Min. size of electric Wires from/to the indoor/outdoor unit	H07RN-F, 4G, 1.25mm ²	
Size of electric input wires	20m or less	
	50m or less	H07RN-F, 3G, 4.0mm ²

2-2 Wired Remote Controller Installation

Accessories

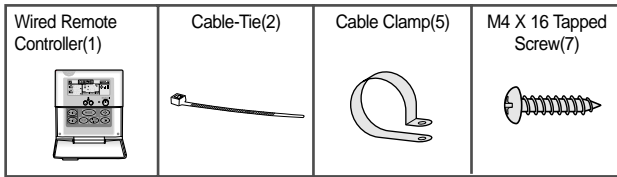

Caution :

- Do Not keep the wired remote controller cables with a 220V cable because the remote controller cables have low voltage.
- Do Not input 220V power to the R1, R2 and R3 in the wired remote controller.

1. Disassemble the wired remote controller by using two grooves on the top of it.

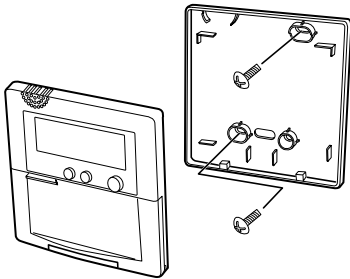

Note : Cable Specifications

Cable type	Double-insulation, 3G
Size of cables	0.3mm ² ~0.75mm ²
Max. length of electric wires from the indoor unit to the wired remote controller	100m

2. Secure the rear cover of the wired remote controller on the wall with two screws.
3. Connect the R1, R2 and R3 terminals in the wired remote controller to the R1, R2 and R3 terminals on the electrical component box each.

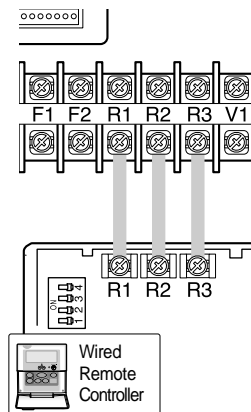

4. Reassemble the wired remote controller.

Caution :

- The optional kits must be installed by an installation specialist.
- Before installing the optional kits, ensure that you have turned off the main power.
- All optional kits cables should be installed according to the national wiring rules and you must install them in the wall not to be touched by users.

2-3 Wireless Remote Controller Installation

Accessories

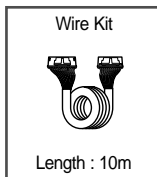
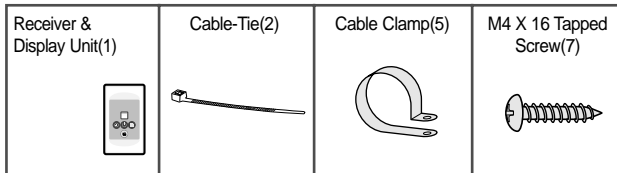
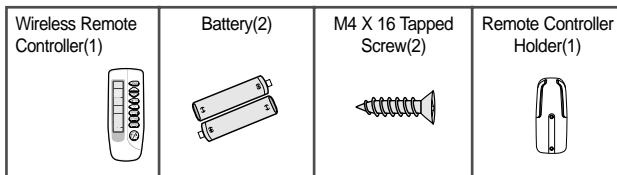

1. Remove the receiver & display unit cover by using the tab on the bottom of it.
2. Open the receiver & display unit.
3. Connect the end of the connector wire to the receiver & display unit and connect the other end of the wire to the electrical component box as shown in figure.

Caution :

- Do NOT keep the receiver & display unit cables with a 220V cable because the remote controller cables have low voltage.







4. Close the receiver & display unit.
5. Secure the receiver & display unit on the wall with two screws.
6. Reassemble the receiver & display unit cover.

Caution :

- The optional kits must be installed by an installation specialist.
- Before installing the optional kits, ensure that you have turned off the main power.
- All optional kits cables should be installed according to the national wiring rules and you must install them in the wall not to be touched by users.

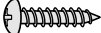
2-4 Centralized Controller Installation

Accessories

Centralized Controller(1) 	Cable-Tie(2) 	Cable Clamp(5) 	M4 X 16 Tapped Screw(7) 
Transmitter(1) 	Spacer Support(4) 	Cable-Tie(2) 	

1. Open the centralized controller cover by using two grooves on the top of it.

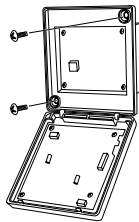

2. Secure the rear cover of the centralized controller on the wall with two screws.
3. Secure the transmitter with four spacer supports into the electrical component box.

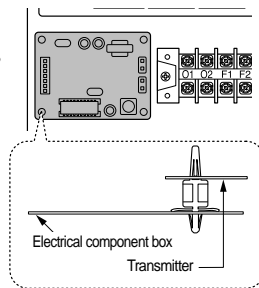

4. Connect the cable from the PCB and to the transmitter.
And connect another cable from the O1, O2 terminals and to the transmitter as shown in figure.

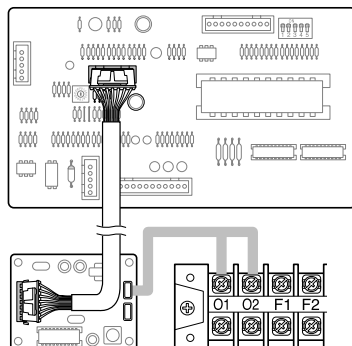

5. Connect the O1 and O2 terminals of the centralized controller to the O1 and O2 terminals on the electrical component box as shown in figure.

Note : Cable Specifications

Cable type	Double-insulation, 2G(Shield Cable)
Size of cables	0.75mm ² ~1.25mm ²
Max. length of electric wires from the indoor unit to the centralized controller	1km

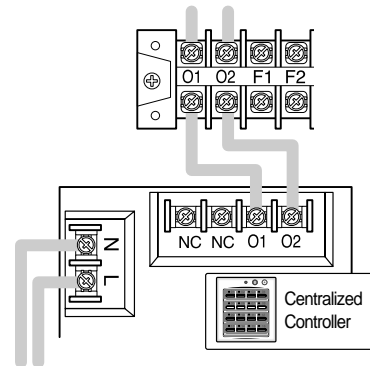

6. Connect the power cables.

Note : Cable Specifications

Cable type	Double-insulation, 2G
Size of cables	0.75mm ² ~1.25mm ²

7. Reassemble the centralized controller.

Caution :

- The optional kits must be installed by an installation specialist.
- Before installing the optional kits, ensure that you have turned off the main power.
- All optional kits cables should be installed according to the national wiring rules and you must install them in the wall not to be touched by users.

2-5 Air Filter Installation

1. Remove the air inlet duct flange.

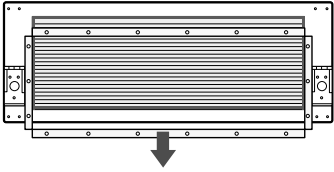

2. Attach the air filter kit to the air inlet side of indoor unit.

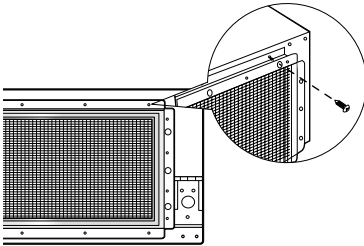

3. To clean the air filter, remove the fixing bracket on the base of air filter kit, then pull out the filter.

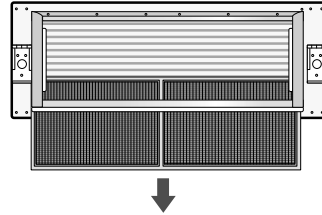

Note: Setting Up Filter Cleaning Cycle

- Adjust the DIP switch(SW2) in the main PCB to the desired position referring the table below.

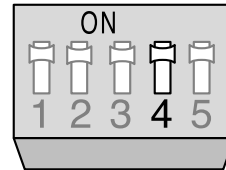

Switch No.	Switch Position	Filter Cleaning Cycle
4	ON	1,000 hours
	OFF	2,000 hours

Caution :

- The optional kits must be installed by an installation specialist.
- Before installing the optional kits, ensure that you have turned off the main power.
- The optional air filter has to be cleaned only by an authorized person or service agent.

2-6 Drain Pump Installation

Care must be taken when installing the drain hose for the indoor unit to ensure that any condensate water is correctly drained outside.

1. Open the side of indoor unit.

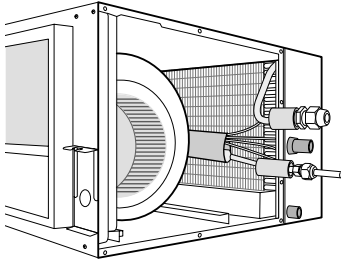

2. Screw the drain pump with two screws.

Note : When installing the drain pump, leave a 7mm space between the bottom of the drain pan and the drain pump.

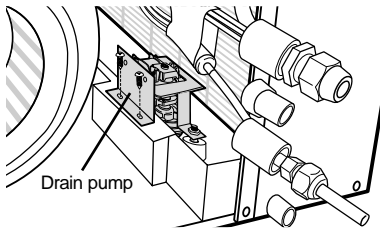

3. Connect the drain hose to the drain socket.

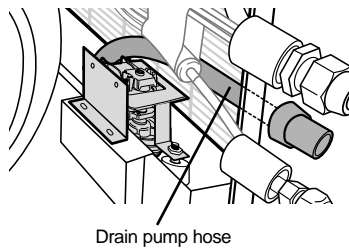

4. Connect the cable to the electrical component box as shown in figure.

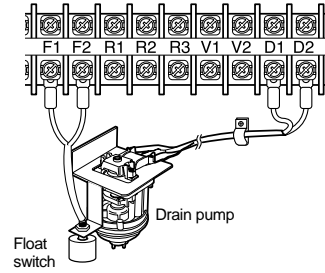

5. Adjust the DIP switch(SW2) on the main PCB according to the table below.

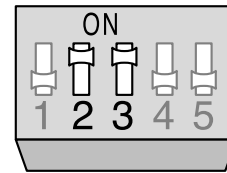

Switch No.	Switch Position
2	ON
3	ON

Note : Wrap the drain tube outlet with an insulating materials.

2-7 Group Control Installation

- * You should adjust the option switches in the electrical component box or on the PCB of the wired remote controller.
- * **Before setting up the option switches, always make sure that you have turned off the main power.**
- * After adjusting the options, you should supply the power. Otherwise, the options will not be applied.

2-7-1. With Wired Remote Controller

A user can operate up to sixteen air conditioners by using the wired remote controller. In this case, the air conditioner can be controlled by only one wired remote controller connected to the indoor unit and cannot be controlled by the others.

1. Connect the R1, R2 and R3 terminals in the wired remote controller to the R1, R2 and R3 terminals in any indoor unit "A" each.
2. Connect the R1 and R3 terminals in the indoor unit "A" to the R1 and R3 terminals in another indoor unit "B".

Caution :

When connecting the cables, you must keep these :

- The R1 terminals must be connected to the R1s.
- The R3 terminals must be connected to the R3s.
- Do not connect the R2 terminals to anywhere.
If you connect R2 terminals, the PCB will be damaged.

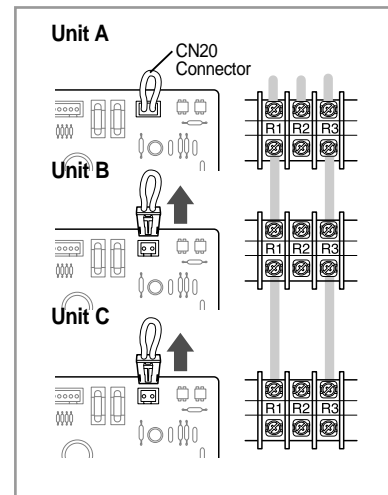

3. Connect the R1 and R3 terminals of "B" to any indoor unit "C" and connect the others as the same way.
4. Remove the CN20 connectors on the sub PCBs except the unit connected with remote controller (Address "0").

Switch No.	Number of indoor unit(s)	Switch No.	Number of indoor unit(s)
0	One	8	Nine
1	Two	9	Ten
2	Three	A	Eleven
3	Four	B	Twelve
4	Five	C	Thirteen
5	Six	D	Fourteen
6	Seven	E	Fifteen
7	Eight	F	Sixteen

5. Remove the CN20 connectors on the sub PCBs except the unit connected with remote controller (Address "0").
6. Adjust the DIP switch No. 2 in the wired remote controller to "ON" position.

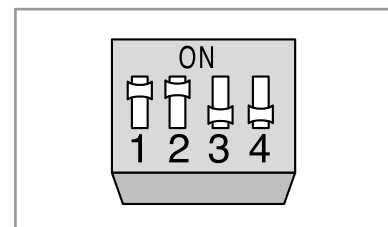

Note : You cannot install the centralized controller when the wired remote controller for a group has already been installed.

2-7-2. With Centralized Controller

A user can turn on/off up to sixteen air conditioners by using the centralized controller. In this case, the user can turn on/off all air conditioners or a specific air conditioner connected with the centralized controller. And each air conditioner can be controlled by its own remote controller(s) depending on the setting.

1. Connect the O1 and O2 terminals in the centralized controller to the O1 and O2 terminals in the indoor unit "A".
2. Connect the O1 and O2 terminals in the indoor unit "A" to the O1 and O2 terminals in another indoor unit "B".
3. Connect the O1 and O2 terminals of "B" to any indoor unit "C" and connect the others as the same way.
4. Adjust the DIP switch(DS01) in the centralized controller to the desired position referring to the table below.

Switch No.	1	2	3	4	Meaning
Switch Position	OFF	OFF	OFF	OFF	The air conditioner is operated by the controller adjusted last among the wired remote controller, wireless remote controller and centralized controller.
	OFF	OFF	OFF	ON	A user can use wired/wireless remote controller when the centralized controller is switched on. And he/she cannot use the remote controller(s) when the centralized controller is switched off.
	OFF	OFF	ON	OFF	The air conditioner(s) can be controlled by only the centralized controller. The user cannot use the wired/wireless remote controller in this case.

5. Adjust the rotary switch on the transmitter to the desired position referring to the table on page 2-11.

Note : You cannot install the centralized controller when the wired remote controller for a group has already been installed.

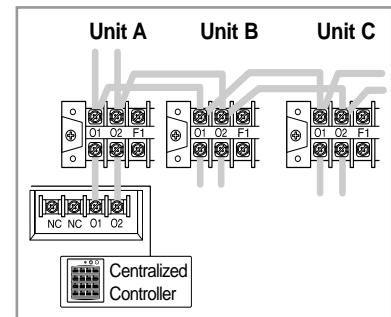
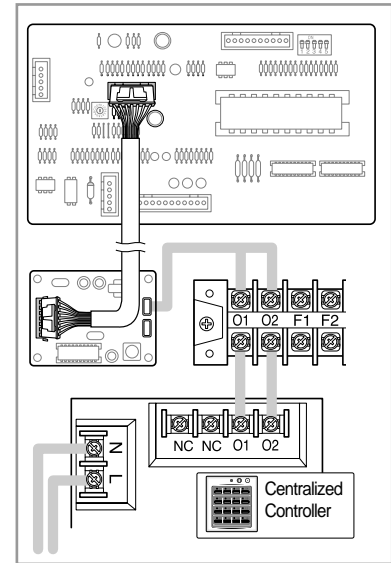

2-8 Setting Up Option Switches

IMPORTANT : Before setting up the option switches, always make sure that you have turned off the main power.

Main PCB in the Indoor Unit

Rotary Switch(SW1)

A user can operate up to sixteen air conditioners by using the wired remote controller. Before controlling more than one air conditioner, you should connect the air conditioner each other. And you must assign addresses to the air conditioners. For further details on connecting air conditioners.

If the user would like to controller only one air conditioner, make sure that the arrow is at "0" position.

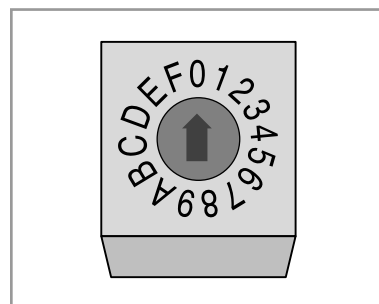

Turn the arrow to the desired position referring to the table below.

Switch No.	Number of indoor unit(s)	Switch No.	Number of indoor unit(s)
0	One	8	Nine
1	Two	9	Ten
2	Three	A	Eleven
3	Four	B	Twelve
4	Five	C	Thirteen
5	Six	D	Fourteen
6	Seven	E	Fifteen
7	Eight	F	Sixteen

DIP Switch(SW2)

Adjust the switch to the desired position referring to the table below.

Switch No.	Option Item	Switch Position		Note
		ON	OFF	
1	Ventilator Fan	Not installed	Installed	Not supplied
2	Drain Pump	Installed	Not installed	Optionally supplied
3	Float Switch	Installed	Not installed	
4	Filter Cleaning Cycle	1,000 hours	2,000 hours	
5	Indoor Fan Motor Speed	Normal	High speed	

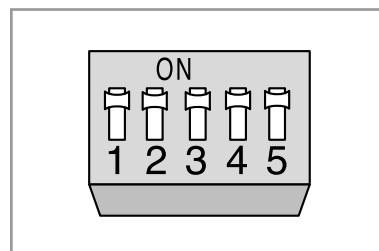

Caution :

- If you do not adjust the switch when not installing the drain pump, "*9" error will occurs. If this happens, adjust the No.2 and No.3 switches to the "OFF" position.

Setting Up Option Switches (Cont.)

Sub PCB in the Indoor Unit

CN20 Connector

Remove the CN20 connector in the sub PCB, if necessary, referring to the table below. (This procedure is needed only when the user would like to control a group by using the wired remote controller.)

Address	Situation of the CN20 Connector
0	Connected
1 - F	Removed

- Note :**
- ◆ Up to 16 air conditioners can be controlled with one wired remote controller.
 - ◆ If the user does not want to control a group, do not remove the CN20 Connector.

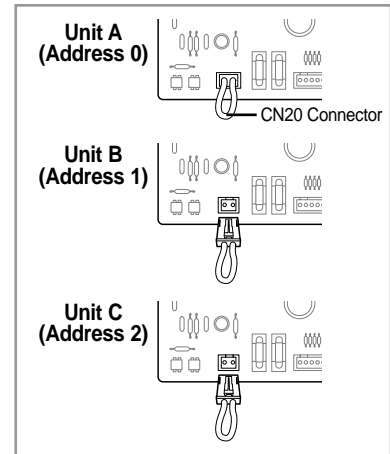

PCB in the wired remote controller

Dip Switch(DS01)

Adjust the DIP switch to the desired position referring to the table below.

Switch No.	Option Item	Switch Position	
		ON	OFF
1	Type of unit	Cooling only	Heat pump
2	Number of air conditioner(s) controlled by the wired remote controller	Group controlling	One indoor unit controlling
3	Basic specification	-	O
4	Using wireless remote controller	Can be used	Cannot be used

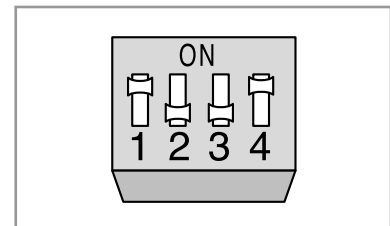

Centralized Controller

DIP Switch(DS01)

Adjust the DIP switch to the desired position referring to the table below.

Switch No.	1	2	3	4	Meaning
Switch Position	OFF	OFF	OFF	OFF	The air conditioner is operated by the controller adjusted last among the wired remote controller, wireless remote controller and centralized controller.
	OFF	OFF	OFF	ON	A user can use wired/wireless remote controller when the centralized controller is switched on. And he/she cannot use the remote controller(s) when the centralized controller is switched off.
	OFF	OFF	ON	OFF	The air conditioner(s) can be controlled by only the centralized controller. The user cannot use the wired/wireless remote controller in this case.

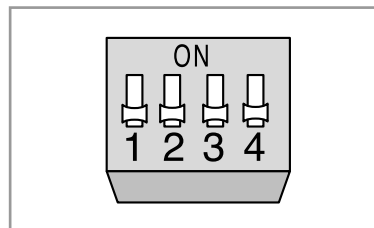

Note : You cannot install the centralized controller when the wired remote controller for a group has already been installed.

Transmitter

Rotary Switch(DS01)

A user can turn on/off up to sixteen air conditioners by using the centralized controller. To use the controller, you must assign addresses to the air conditioners. For further details on connecting air conditioners.

If the user would like to controller only one air conditioner, make sure that the arrow is at "0" position.

Turn the arrow to the desired position referring to the table below.

Switch No.	Number of indoor unit(s)	Switch No.	Number of indoor unit(s)
0	One	8	Nine
1	Two	9	Ten
2	Three	A	Eleven
3	Four	B	Twelve
4	Five	C	Thirteen
5	Six	D	Fourteen
6	Seven	E	Fifteen
7	Eight	F	Sixteen

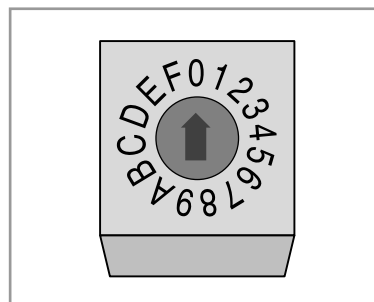

Original Position of Option Switches

The option switches are preset by the manufacturer. Refer to the table below, if necessary.

Option Place	Component No.	State
Main PCB in the indoor unit	Rotary Switch(SW1)	0
	DIP Switch(SW2)	ON
	Jumper Wire(SW05)	SHORT
Sub PCB in the indoor unit	CN20 Connector	Connected
Wired Remote Controller	DIP Switch(DS01)	OFF
Centralized Controller	DIP Switch(DS01)	OFF
Transmitter	Rotary Switch(DS01)	0

Note : Before setting up the options, always make sure that you have switched off the main power. After adjusting the options, you should supply the power. Otherwise, the options will not be applied.

MEMO