

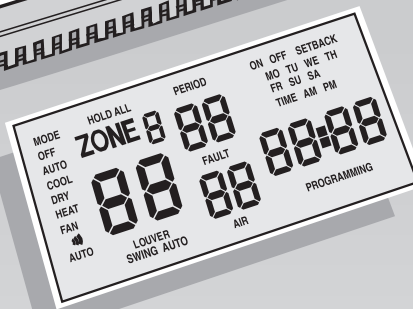

Zone Manager

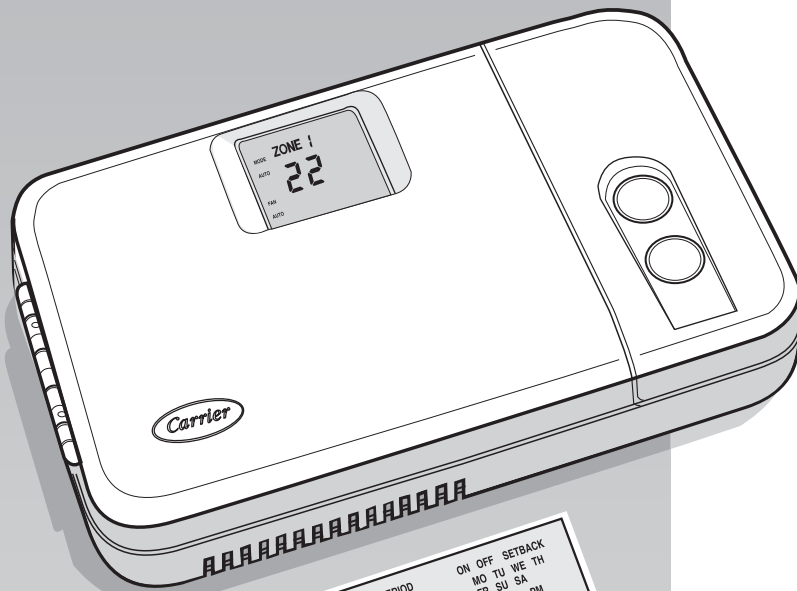

CE



INSTALLATION MANUAL

Zone Manager

Installation manual

This control system only operates with indoor units of the following models:
40 GKX and 40 QKX Cassette, 42 HWX and 42 HWS Hi-Wall, 42 VKX Console.
For installation instructions of this unit, refer to the relevant manuals.

Contents

	Page
General information	2
Characteristics	2
Choosing the installation site	3
Installation	4
Electrical connections	5/7
Configuration	8/13
Unit zone addressing	14/15
Test System	15
Smart Start function	16
Trouble Shooting	17

Installation Flow Chart

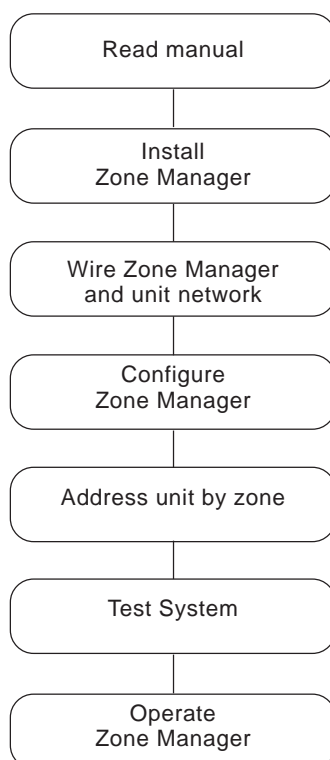

Zone Manager

General information and characteristics

Dimensions (mm)

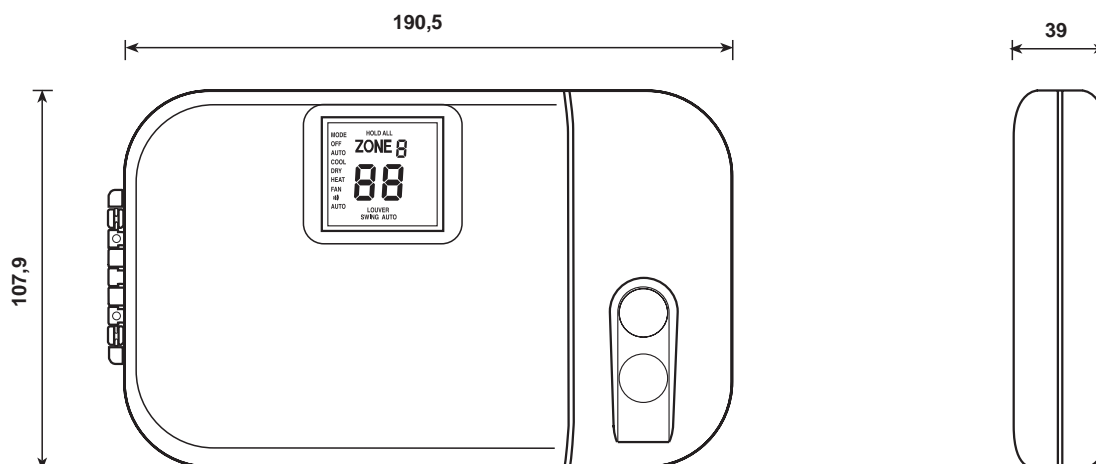

IMPORTANTE:

Read this instruction manual thoroughly before starting the installation.

- For trouble-free installation, which should be carried out by a qualified installer, follow the installation chart sequence.
- Follow all current national safety code requirements. In particular ensure that a properly sized and connected ground wire is in place.
- After installation thoroughly test the system operation and explain all system functions to the owner.
- Leave this manual with the owner for consultation during future periodic maintenance.
- Dispose of packaging material in accordance with local requirements.
- The manufacturer denies any responsibility and warranty shall be void if these installation instructions are not observed.
- Inspect equipment for damage due to improper transportation or handling: file an immediate claim with the shipping company. Do not install or use damaged units.
- In case of any malfunctioning turn the unit off, disconnect the mains power supply and contact a qualified service engineer.

Models

There is only 1 model, which is easily configurable for all installations.

Products that the Zone Manager can Interface

40 GKX and 40 QKX	CASSETTE
42 HWX and 42 HWX	HI-WALL
42 VKX	CONSOLE

Wiring

- The Zone Manager can be connected to one unit (that is the first in the network).
- Each unit must be connected one after the other (daisy chain).
- If the Zone Manager is to use its room sensor the controller has to be located in the same area as the addressed unit(s) number 1.

Power

Note that the Zone Manager requires no batteries and is not "power stealing". It requires **12 VDC** to be connected for proper operation, which is easily obtained from any of the unit. The Zone Manager will not operate without this connection.

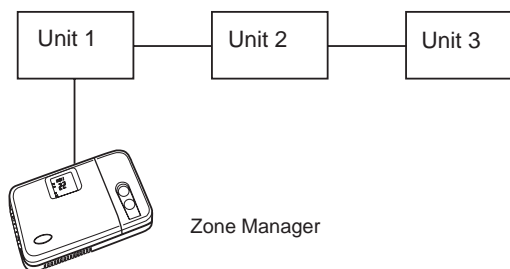

Zone Manager

Correct layout Daisy chain

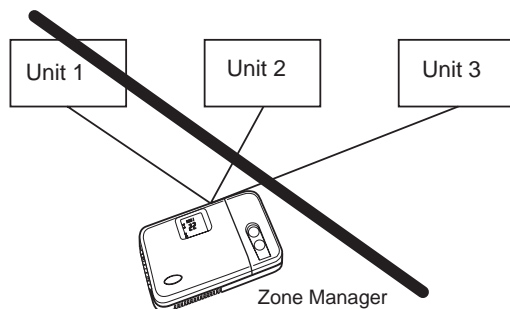

Zone Manager

Incorrect layout must not be used Start Layout

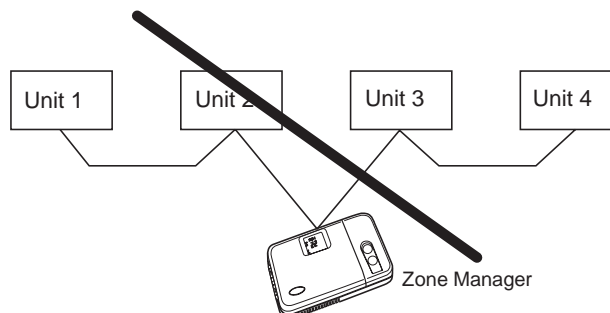

Zone Manager

Not recommended TEE connection

Minimum clearances

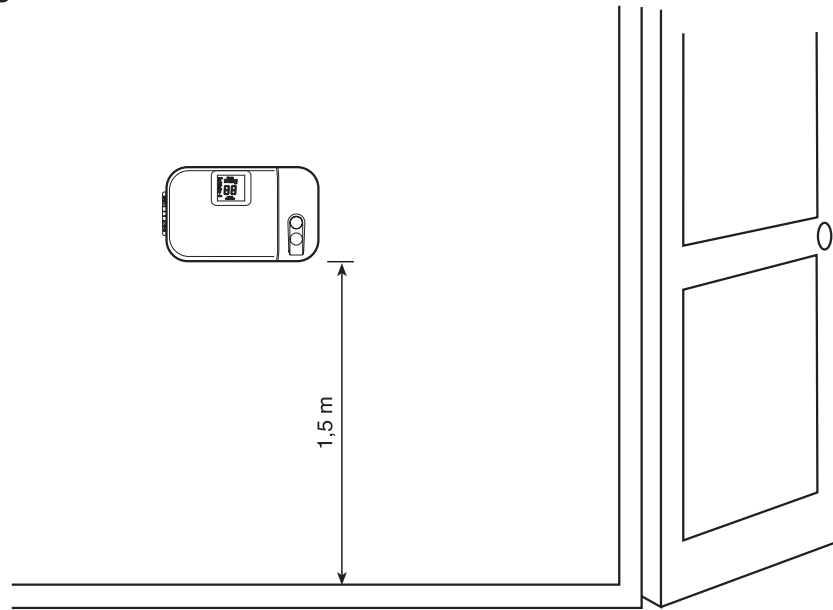

The Zone Manager Location

The Zone Manager can be located anywhere. However, if the installation requires the systems in the location in zone 1 to use the Air Sensor on the Zone Manager; then, the controller should be mounted:

- Approximately 1.5 m from floor.
- In the same area where the units from group are located, preferably on an inside partitioning wall.
- On a section of wall without pipes or duct work.

If the air sensor on the Zone Manager has been selected, it should NOT be mounted:

- Close to a window, on an outside wall, or next to a door leading to the outside.
- Exposed to direct light or heat from a lamp, sun, fireplace, or other temperature-radiating object which may cause a false reading.
- Close to or in direct airflow of a heating or cooling supply.
- In areas with poor air circulation, such as behind a door or in an alcove.

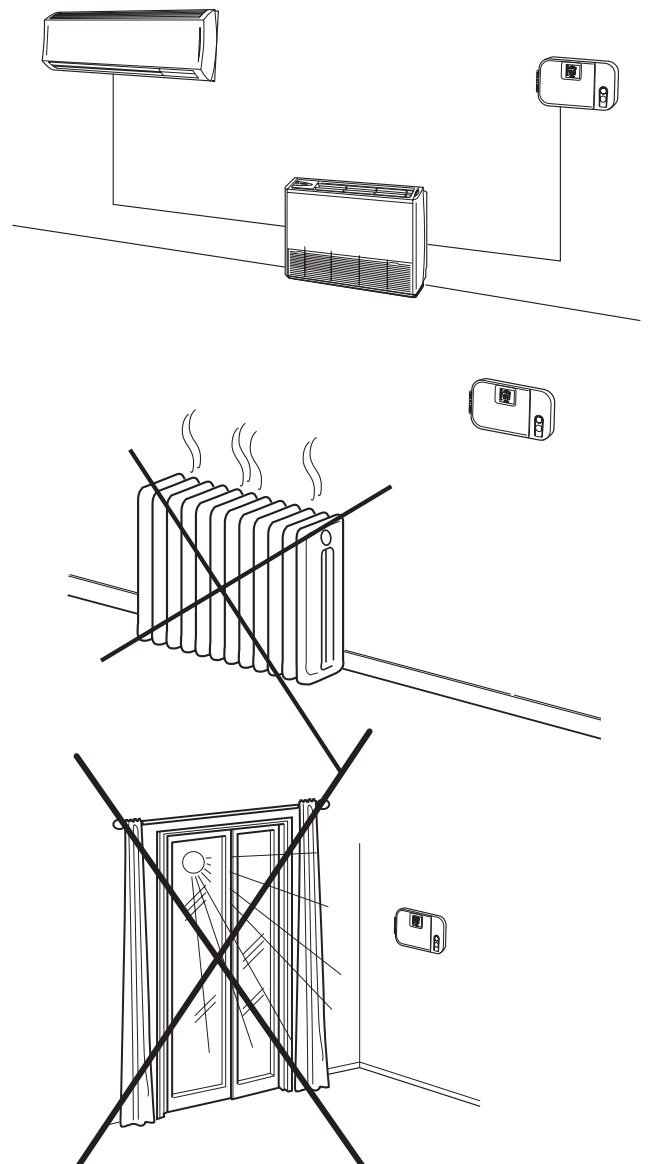

Zone Manager

Installation

Considerations

- Maximum of 500 m of total network wiring.
 - Maximum of 32 units allowed on a system.
 - Maximum number of zones 8.
 - Only zone 1 can use the room sensor located on the Zone Manager.
- Network wiring must be daisy chained.

CAUTION:
Star configuration can cause improper operation of the Zone Manager.

Mounting

WARNING:
Before installing the Zone Manager, turn off all power to the unit that will supply power to the Zone Manager. Electrical shock can cause personal injury or death.

- Turn OFF all power to unit.
- Open the Zone Manager rear door (mounting base) to expose mounting holes. The base can be removed to simplify mounting (snap apart carefully at hinge to separate mounting base from remainder of the Zone Manager).
- Route the Zone Manager wires through the large hole in the mounting base. Level mounting base against wall (for aesthetic value only the Zone Manager need not be level for proper operation) and mark the wall through the 2 mounting holes.
- Drill two 5 mm mounting holes in wall where marked.
- Secure mounting base to wall with 2 screws and anchors provided, (additional anchoring holes available for more secure mounting if needed) making sure all wires extend through hole in mounting base.
- Adjust length and routing of each wire to reach the proper terminal in the connector block on the mounting base, with 6 mm of extra wire (strip only 6 mm of insulation from each wire to prevent adjacent wires from shorting together when connected).
- Match and connect equipment wires to proper terminals in the connector block (See section "Electrical connections"). Both power and communication wires must be connected correctly for proper Zone Manager operation.
- Push any excess wire into the wall and against mounting base. If the air sensor is being used on the Zone Manager, seal hole in wall to prevent air leaks. Leaks can affect sensor operation.
- Snap hinge back together.
- Close the Zone Manager assembly making sure pins on back of circuit board align with sockets in connector.

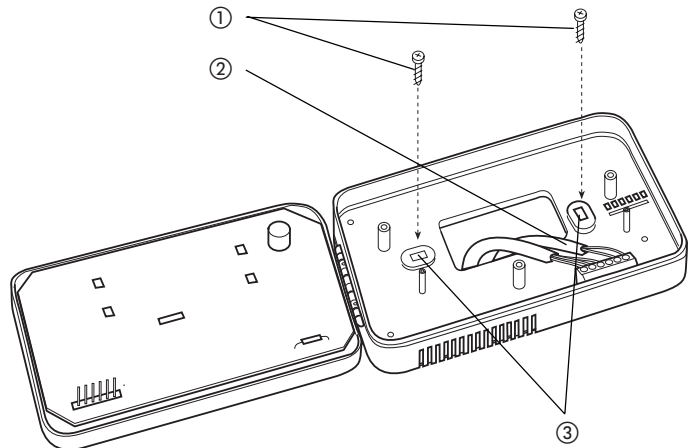
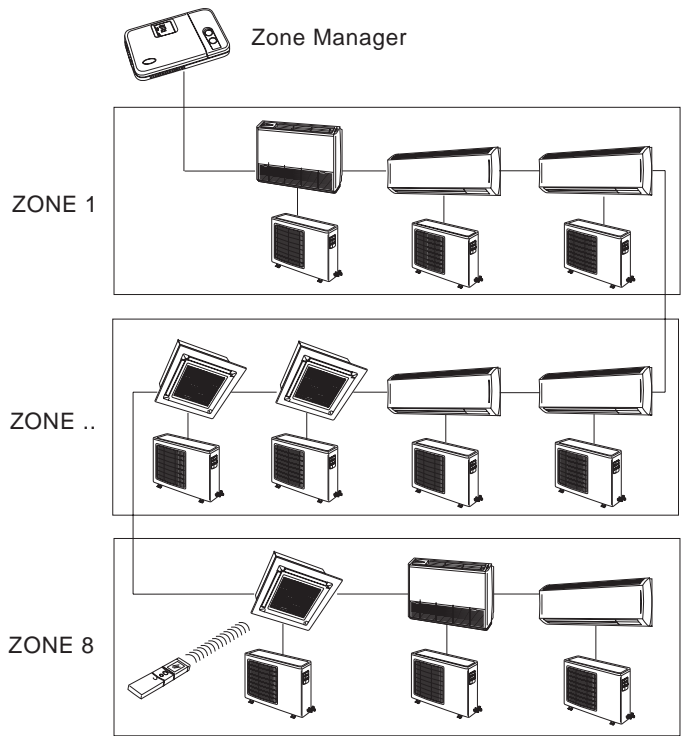

Mounting

- ① Mounting screws
- ② Connection cables
- ③ Holes

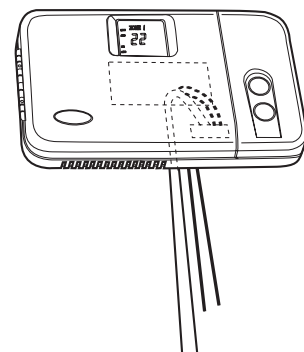

Zone Manager

Electrical connections

Installation of the kit into the unit

Skip this paragraph if the unit does not need the installation of a kit.

Kit part number	Unit type
40 GKX	40QKX900---102-40
40 QKX	None
42 HWX and 42 HWS	40QKX900---102-40
42 HWX with electric heater	None
42 VKX	40QKX900---102-40

CAUTION:
Improper wiring or installation may damage the Zone Manager.
Check to make sure wiring is correct before proceeding with turning on unit.

A communication board is required for all products that are networked to a Zone Manager system. Reference the table on products that the Zone Manager can be networked with, it identifies whether an installation kit is required or not.

If required:

- A kit consists of a communication board, a 9 pin wire harness and a ground wire and a jumper.
- The Jumper has to be installed to connector **J3** in the Intersec communication board (only for models 42HWX, 42HWS and 42VKX).
- The 9 pin wire harness must be attached to connector **J1** on the communication board and routed to the **J2** EXPANSION connector on the main control board. The main control board will have to be removed to make this connection. Once the wire harness is attached to the main control board, it should be inserted back into the control box (only for models 42HWX, 42HWS and 42VKX)
- The ground wire must be attached from the ground post on the unit, to the 4.8 mm quick connect (**P1**) on the communication board.

ATTENTION:
Two ground wires are available: use the right one for the corresponding unit.

- Now, the network communication wires need to be installed into the 3 poles terminal block on the communication board.
- Finally, if this unit will power the Zone Manager, 12V power wires need to be installed into the 2 position terminal block on the communication board.
- Once all the wiring is complete, the communications board can be inserted into the control box.

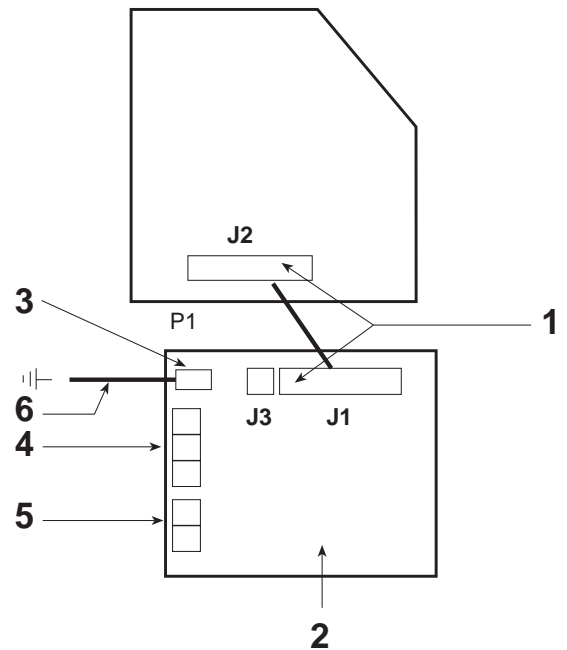

- 1 Board to board connector
- 2 Intersec communication board (COM)
- 3 P1 earth connector
- 4 RS 485 communications
- 5 ZM power supply only required for the unit closes to the ZM
- 6 Cable connecting board to ground post



HWX - HWS - GKX

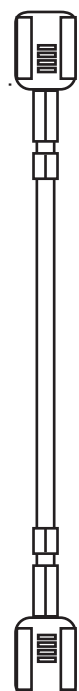

VKX

Zone Manager

Electrical connections

Diagram 1: wiring for Zone manager

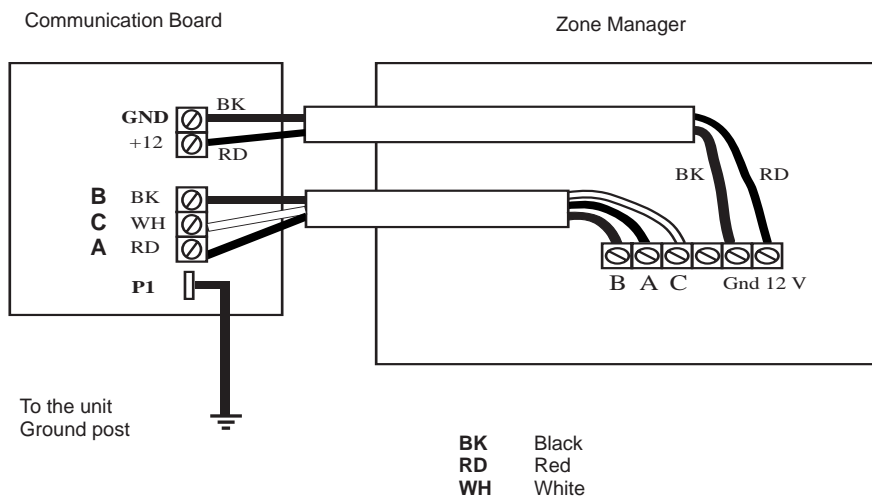

Wiring Zone Manager to master unit

The Zone Manager has the ability to control up to 32 units. To insure the correct operation of this system the wiring must be installed using the following guidelines.

WARNING:

Before connecting any wiring to the Zone Manager, turn off all power to the unit that will supply power to the Zone Manager. Electrical shock can cause personal injury or death.

The Zone Manager is connected to the master unit using the following instructions. Reference Diagram 1 when making these connections.

POWER CABLE CONNECTIONS (2 conductor, double insulated cable)

- In the Zone Manager, loosen the screws on the terminals labeled **+12V** and **GND**.
- Insert the RED wire into the terminal labeled **+12V**. Tighten the screw.
- Insert the BLACK wire into the terminal labeled **GND**. Tighten the screw.
- At the communications board in the master unit product, loosen the screws on the terminals labeled **+12V** and **GND**.
- Insert the RED wire into the terminal labeled **+12V**. Tighten the screw.
- Insert the BLACK wire into the terminal labeled **GND**. Tighten the screw.
- Power cable installation complete.

COMMUNICATION CABLE CONNECTIONS (3 conductor, double insulated, shielded cable)

- In the Zone Manager, loosen the screws on the terminals labeled **A**, **B**, and **C**.
- Insert the RED wire into the terminal labeled **A**. Tighten the screw.
- Insert the BLACK wire into the terminal labeled **B**. Tighten the screw.
- Insert the WHITE wire into the terminal labeled **C**. Tighten the screw.
- At the communications board in the master unit product, loosen the screws on the terminals labeled **A**, **B**, and **C**.
- Insert the RED wire into the terminal labeled **A**. Tighten the screw.
- Insert the BLACK wire into the terminal labeled **B**. Tighten the screw.
- Insert the WHITE wire into the terminal labeled **C**. Tighten the screw.
- Connect the shield of the cable to the master unit **GND** post.

Communication cable installation complete.

NOTE:

The shield for the communications cable is not connected at the Zone Manager. Terminate the shield in such a manner that it will not short with anything in the Zone Manager.

Wiring Materials required (supplied by installer)

- 1 small screwdriver
- 3 x 0,5 and 2 x 0,5 mm² multiple cables, double insulated. Suggested type: H03VV-F.

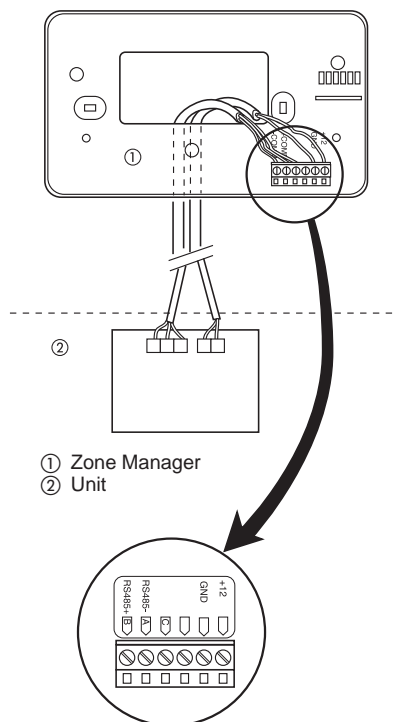
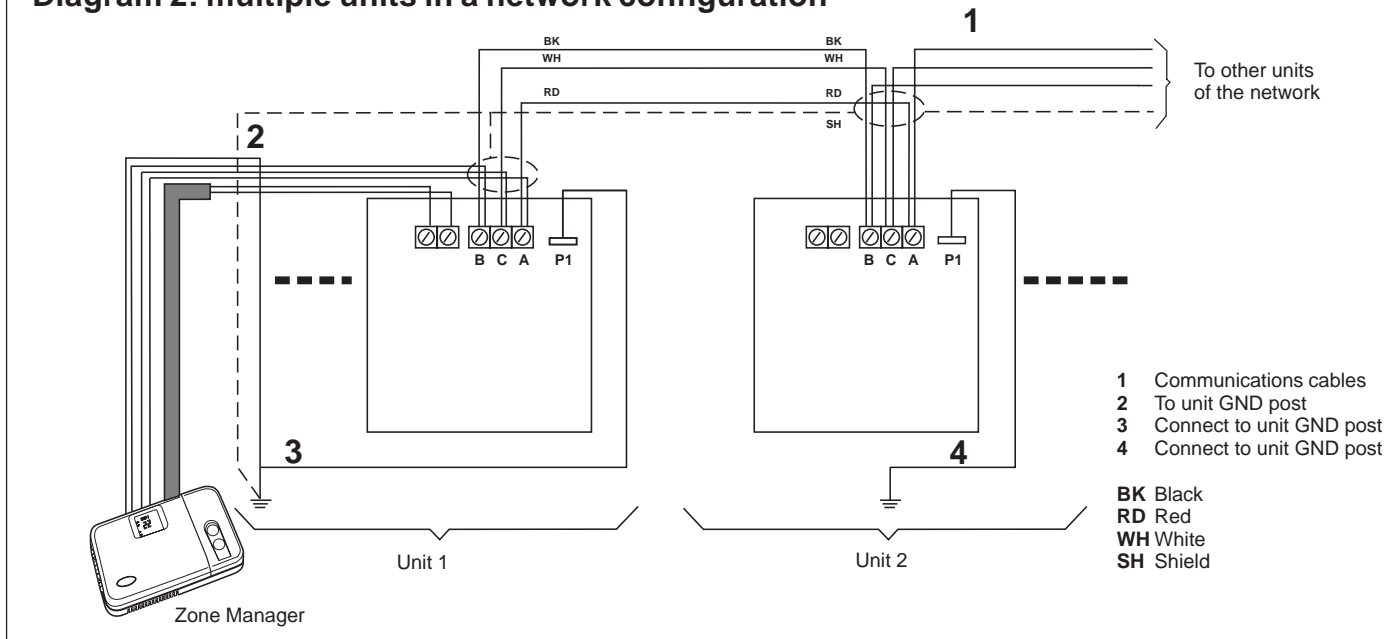

Diagram 2: multiple units in a network configuration



Networking multiple units

Multiple units can be connected together and controlled by a single Zone Manager. Diagram 3 is a block diagram of multiple units networked into a system controlled by 1 Zone Manager. To accomplish this the communication boards from the networked units must be wired together in a daisy chain configuration. The following section describes how to do the wire installation for a networked system.

Wiring for networking multiple units

Materials required for wiring multiple units into a network. Reference Diagram 2 when doing this installation.

COMMUNICATION CABLE CONNECTIONS (3 conductor, double insulated, shielded cable)

1. At the communications board in the master unit, loosen the screws on the terminals labeled **A**, **B**, and **C**.
2. Insert the RED wires from daisy chained communication cables into the terminal labeled **A**. Tighten the screw.
3. Insert the BLACK wire from daisy chained communication cables into the terminal labeled **B**. Tighten the screw.
4. Insert the WHITE wire from daisy chained communication cables into the terminal labeled **C**. Tighten the screw.
5. Connect the SHIELD from the daisy chained cables together.

Continues steps 1-4 until you reach the last unit in a network. At this point only 1 wire needs to be inserted into each terminal.

Be sure in all cases when communications cables are daisy chained, the shield wires are also daisy chained.

The shield wire must be grounded to the unit ground post in one location on the system.

NOTE:

The shield for the communication cables is tied to a unit **GND** post at one point only, the remaining shields are daisy chained together.

CAUTION:

Do not tie the shield to a GND post at more than 1 location.

Diagram 3: networking of multiple units

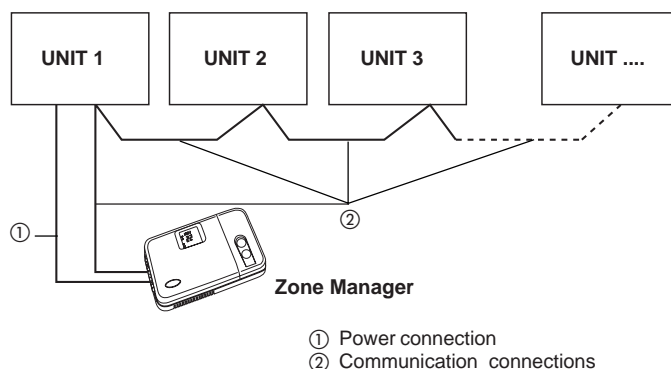

Zone Manager Configuration

Configuration options are intended to be selected at installation and normally are not modified by the end user. These options are not discussed in the end user's manual and therefore must be made as part of the installation. A special procedure allows entry into the configuration mode. The Zone Manager will automatically exit this mode if no button is pressed within 20 seconds. While in configuration mode, 9 choices can be made:

- Fahrenheit (F) or Celsius (C) (Default: Celsius).
- Room Air Override **ON** or **OFF** (Default: OFF).
- Cooling only (C) or Heat Pump (H) (Default: Heat Pump).
- Auto Mode Setback Deadband (Default 16): Value Adjustment.
- Number of Zone Installed (Default 1): Value Adjustment.
- Smart Start **ON** or **OFF** (Default: ON).
- Military Time (**ON**) or Standard Time (**OFF**) (Default: Standard Time).
- Local unit override **ON** or **OFF** (Default: OFF).
- Ability to not allow mode or schedule changes: Lock (Default : UL, Unlocked)

In configuration mode ON is represented by the display "On" and OFF is represented by the display "OF."

An explanation for each of these and how to enter the configuration mode follows.

To enter configuration mode

Press and hold the "FAN" button for approximately 5 seconds until the normal display disappears and reads "1-" and either "C" or "F". You are now in the configuration mode.

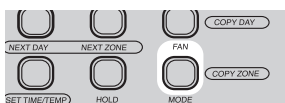

NOTE:

If no button is pressed for 20 seconds, the Zone Manager will exit configuration mode and resume normal operation. To re-enter configuration mode, "FAN" button must be pressed and held again.

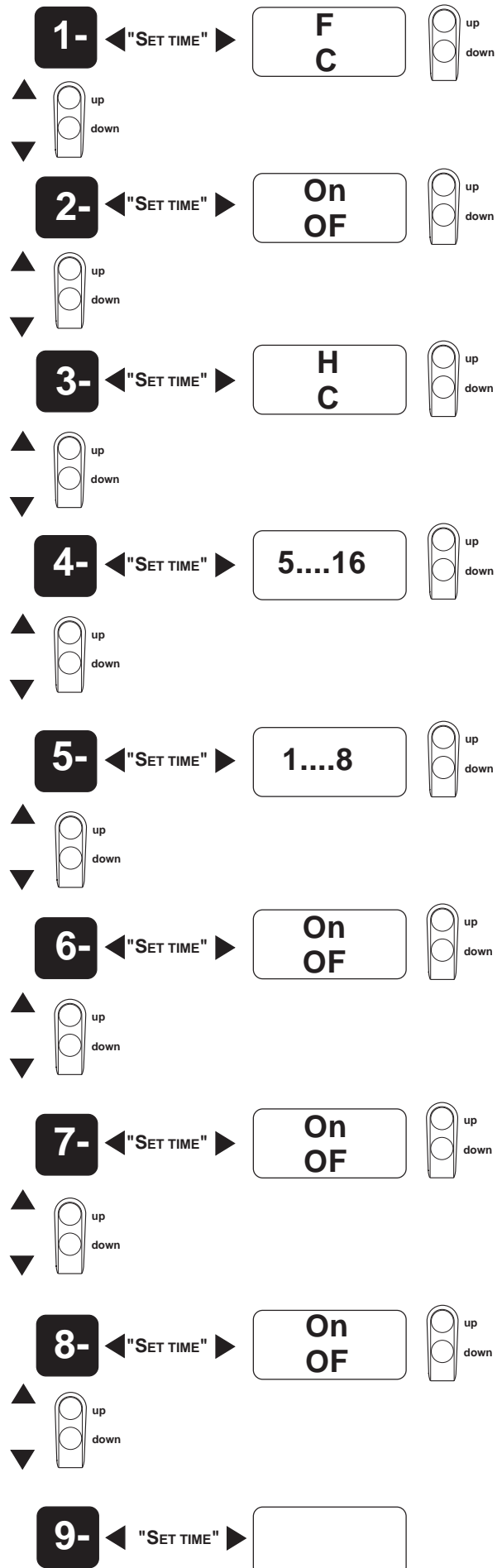

Zone Manager Configuration

To change multiple configuration parameters:

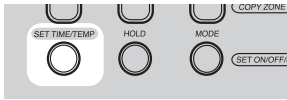

To make another modification to configuration, depress the "SET TIME/TEMP" button. This will toggle between selecting the Configuration Option and the Configuration Value. To change the selection, press the "up" and "down" arrows until the desired configuration selection is displayed.

1- FAHRENHEIT OR CELSIUS

Select between Fahrenheit (F) or Celsius (C) operation. Factory default is Celsius.

To select while in configuration mode:

- The Configuration Option ("1-") and the current selection should be displayed.

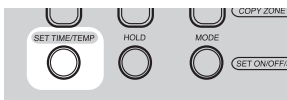

- Depress the "SET TIME/TEMP" button to alter the current selection (current selection will now blink).



- Use either the "up" or "down" button to change between "F" or "C".

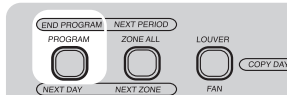

- To end configuration, either depress the "END PROGRAM" button or do not press any buttons for 20 seconds.

2- ROOM THERMISTOR OVERRIDE

Select whether the units in zone 1 will use room temperature sensor in the Zone Manager "on" or whether they will use the air sensor at the units "of". Factory default is OFF. If the chosen option is "on" the room air temperature will be displayed.

CAUTION:
If the room air sensor on the Zone Manager is selected, installation of the Zone Manager is critical.

To select while in configuration mode:



- Press the "up" or "down" button until "2-" is displayed.

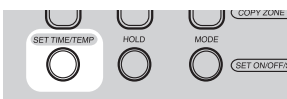

- Depress the "SET TIME/TEMP" button to alter the current selection (current selection will now blink).

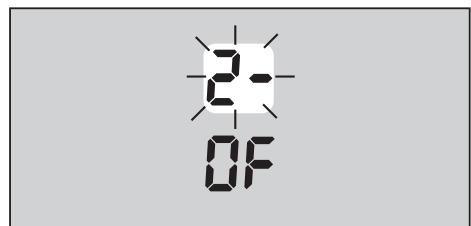
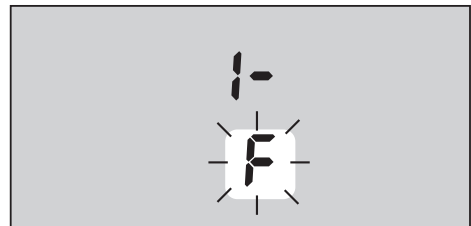
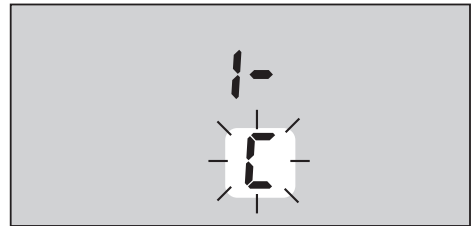
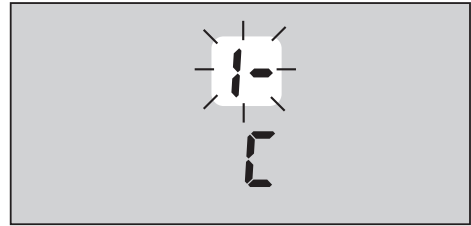

Zone Manager Configuration

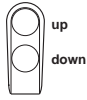

- Use either the "up" or "down" button to change between "OF" (OFF) and "On" (ON).

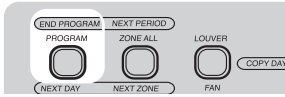

- To end configuration, either depress the "END PROGRAM" button or do not push any buttons for 20 seconds.

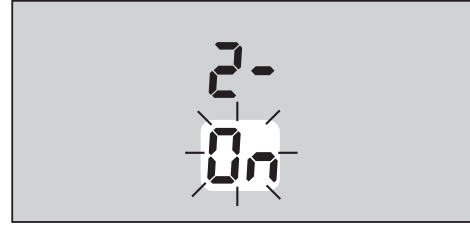

3- COOLING ONLY OR HEATPUMP: SELECTION

Select whether the system is a cooling only or Heat Pump system. If there is a combination of cooling only and heatpump units on the system, then Heat Pump must be selected. Factory default is Heat Pump.

To select when in configuration mode:



- Press the "up" or "down" button until "3-" is displayed.

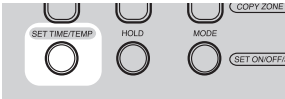

- Depress the "SET TIME/TEMP" button to change the current selection (current selection will now blink).



- Use either the "up" or "down" button to change between "H" (Heat Pump) and "C" (Cooling only).

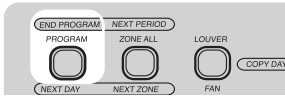

- To end configuration, either depress the "END PROGRAM" button or do not push any buttons for 20 seconds.

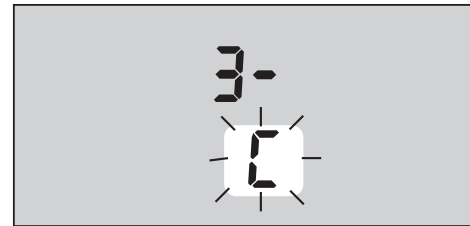
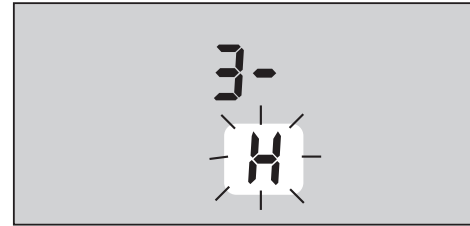
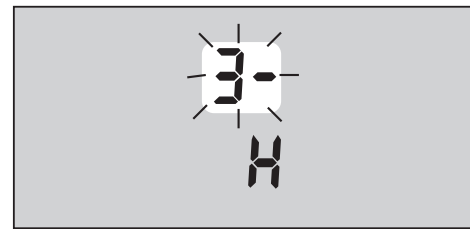

4 - AUTO MODE SETBACK DEADBAND: ADJUSTMENT

Select the number of degrees to setback the heating and cooling setpoints while a unit is in auto mode during a setback period. Factory default is 16 degrees.

To select when in configuration mode:



- Press the "up" or "down" button until "4-" is displayed.

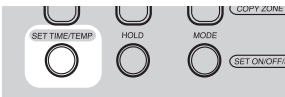

- Depress the "SET TIME/TEMP" button to change the current selection (current selection will now blink).

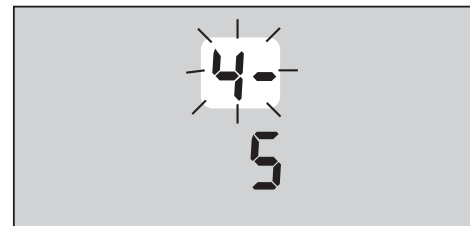

Zone Manager Configuration



- Use either the "up" or "down" button to change the current number of degrees to setback. Allowable selections are 5-32 degrees.

NOTE:

The scale of the temperature is dependent up on the currently configured scale. If the configuration item "1-" is set to "F" and configuration item "4-" has a value of 16, then an Auto Mode Setback Deadband of 16°F will be used. If the configuration item "1-" is set to "C" and configuration item "4-" has a value of 16, then an Auto Mode Setback Deadband of 16°C will be used.

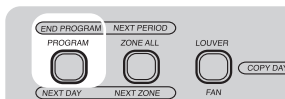

- To end configuration, either depress the "END PROGRAM" button or do not push any buttons for 20 seconds.

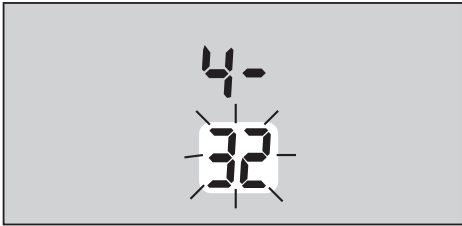
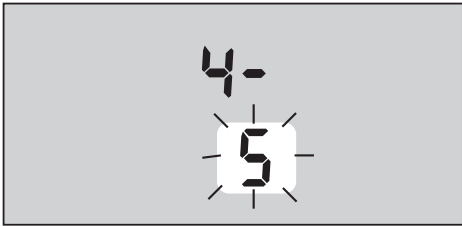

5- NUMBER OF ZONES INSTALLED

This adjustment controls the number of zones on the system. Factory default is 1 zone. To adjust when in configuration mode:



- Press the "up" or "down" button until "5-" is displayed.

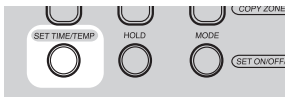

- Depress the "SET TIME/TEMP" button to change the current selection (current selection will now blink).



- Use either the "up" or "down" button to change the number of zones installed, allowable selection are 1- 8 zones.

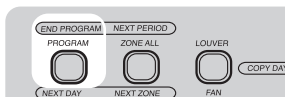

- To end configuration, either depress the "END PROGRAM" button or do not push any buttons for 20 seconds.

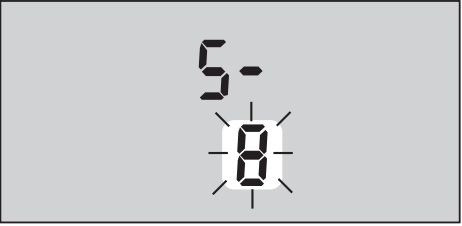
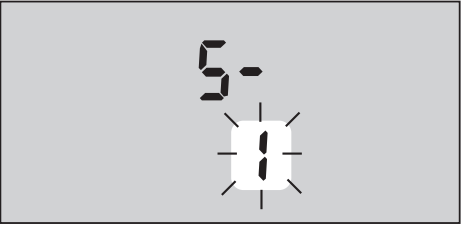
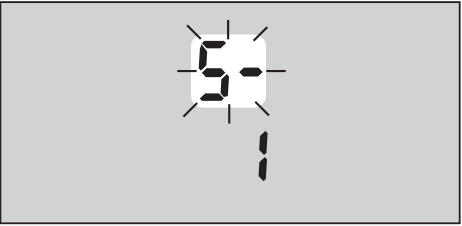

Zone Manager Configuration

6- SMART START ACTIVE

This selection allows you to select whether Smart Start is active or not. Factory default is "On". See Algorithm Descriptions for an explanation of Smart Start. To adjust when in configuration mode:



- Press the "up" or "down" button until "6-" is displayed.

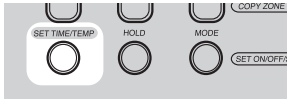

- Depress the "SET TIME/TEMP" button to change the current selection (current selection will now blink).



- Use either the "up" or "down" button to change your selection to "On" (ON) or "OF" (OFF).

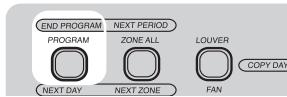

- To end configuration, either depress the "END PROGRAM" button or do not push any buttons for 20 seconds.

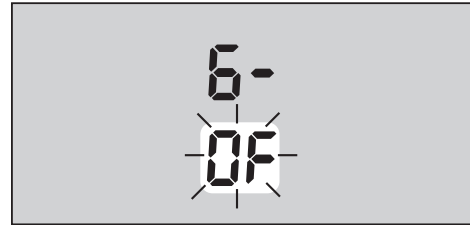
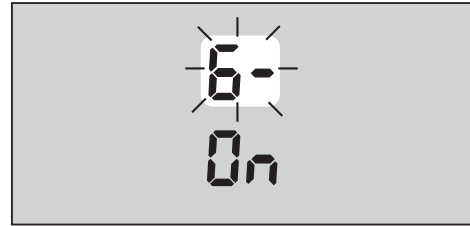

7- MILITARY OR STANDARD TIME

This adjustment controls whether time is displayed in military (24-hour clock) or standard format (12-hour AM/PM clock). Factory default is "On" for military time.



- Press the "up" or "down" button until "7-" is displayed.

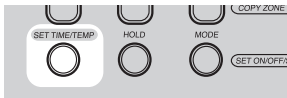

- Depress the "SET TIME/TEMP" button to change the current selection (current selection will now blink).



- Use either the "up" or "down" button to change to "On" (military time) or "OF" (standard time).

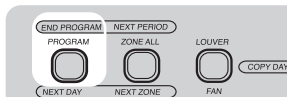

- To end configuration, either depress the "END PROGRAM" button or do not push any buttons for 20 seconds.



Zone Manager Configuration

8- LOCAL UNIT OVERRIDE

If Local Unit Override is active, certain information (operating mode, desired temperature, fanspeed, louver setting) from the Zone Manager will be ignored by a unit that has recently been locally controlled. The unit will control to the local settings for at least one hour. Factory default is "OF".

To adjust when in configuration mode:



- Press the "up" or "down" button until "8-" is displayed.

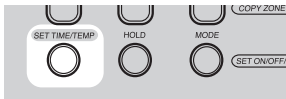

- Depress the "SET TIME/TEMP" button to change the current selection (current selection will now blink).



- Use either the "up" or "down" button to change to "On" for active Local Unit Override or "OF" for disabled local Unit override.

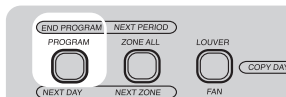

- To end configuration, either depress the "END PROGRAM" button or do not push any buttons for 20 seconds.

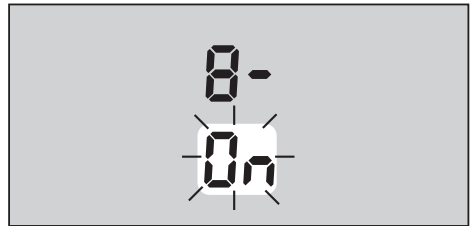
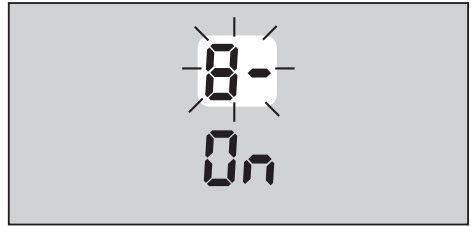

9- LOCK MODE

If this option is active (Lo) after 4 minutes the installer exits installation mode the operator will not be able to change mode or program schedule.

If the operator press the "MODE" or "PROGRAM" button "Lo:c" will be displayed. Default is unlocked (UL).

To adjust when in configuration mode:



- Press the "up" or "down" button until "9-" is displayed.

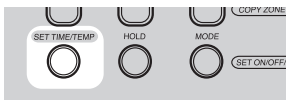

- Depress the "SET TIME/TEMP" button to change the current selection (current selection will now blink).



- Use either the "up" or "down" button to change to "Lo" to Lock mode and program schedule or "UL" to allow the end user modify these parameters.

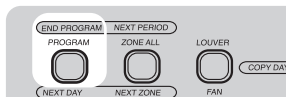

- To end configuration, either depress the "END PROGRAM" button or do not push any buttons for 20 seconds.

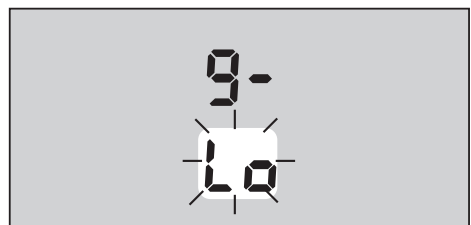
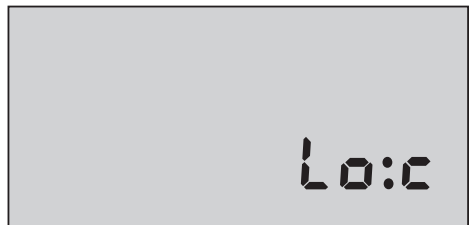

Zone Manager

Unit zone addressing

Unit zone addressing

The units must have their communications address changed to the zone number in which they will occupy.

Figure shows an example using 9 units and 4 zones.
For this example, the values shown in Table 1 should be used.

For this example, units **B, C, E, H, and I** will occupy Zone 4. Therefore their communications addresses should be configured to address 4.

The numbering of the zones must begin with Zone 1. Any further zones must be added in a sequential order.

For example, configuring the zones 1, 2, 3, and 5 will result in improper operation. (Fault code C4 would be seen).

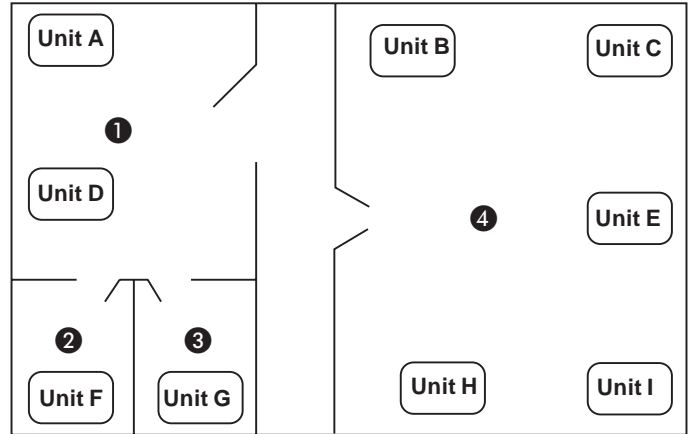

Example unit configuration

Configuring the communications address using the IR remote

Remove the sliding panel from the remote exposing the batteries and clock set button.

ENTERING CONFIGURATION MODE

- With a pointed object, such as a ball-point pen, depress the clock set button.
- While depressing the clock set button, hold the "MODE" button depressed for 3 seconds. Until the LCD display will change to display the number one and the word "Id:un" Release the clock set and "MODE" buttons.
- Press the mode button twice to cycle through the configuration menus and select address. The LCD display will display an "Ad:dr" when the address configuration menu is selected.

SELECTING ADDRESS

- Press the "up" or "down" buttons to change the address number to configure the unit.

NOTE:

While it is possible to configure a communications address from 1-32, a unit must have an address from 1-8 to work properly with the Zone Manager.

SENDING ADDRESS TO THE UNIT

While pointing the remote at the unit, press the "ON/OFF" button. The unit will quickly beep as verification of receiving the new communications address.

EXIT CONFIGURATION MODE

Press the "FAN" button on the remote to exit the configuration menu.

Configuring the CCN Address using the Group Controller

ENTERING CONFIGURATION MODE

Please make sure the Group Controller is properly wired to the unit to configure the address.



- On the Group Controller press and hold the "FAN/LOUVER" button for 5 seconds. After 5 seconds a "1-" will appear.

Table 1: CCN addresses for units

Unit	A	B	C	D	E	F	G	H	I
Communic. Address	1	4	4	1	4	2	3	4	4

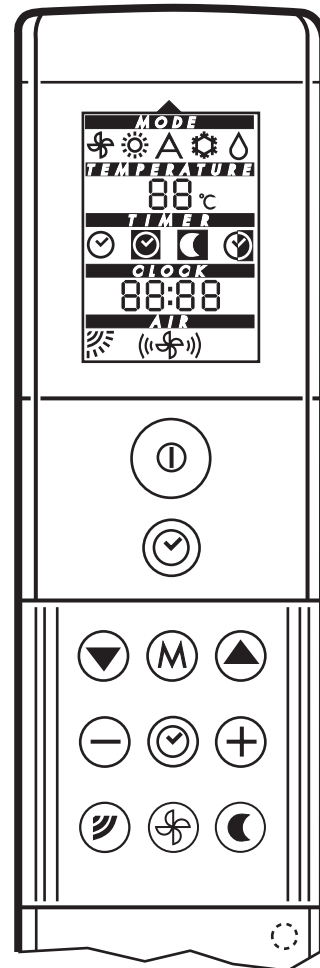

Remote control

Zone Manager

Unit zone addressing and test system



- Press the "FAN/LOUVER" button to enter the communications address configuration menu.

SELECTING THE ADDRESS



- Press the "up" or "down" buttons to change the address number to configure the unit.

SENDING THE ADDRESS TO THE UNIT

It is sent automatically.

NOTE:

While it is possible to configure a communications address from 1- 32, a unit must have an address from 1- 8 to work properly with the Zone Manager.

EXITING CONFIGURATION MODE

- The Group Controller will exit from the configuration menu and configure the unit after 10 seconds without a button being pressed.

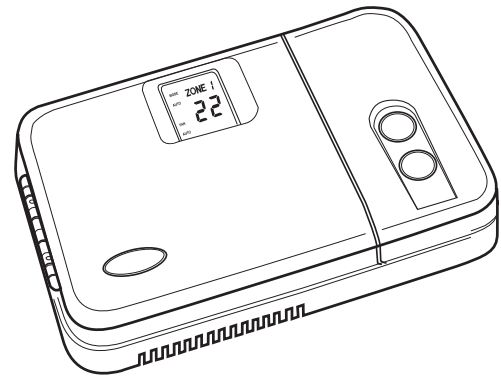

Group Controller



Test System Installation

To assist with installation wiring and unit zone addressing issues, an installation test mode exists, that allows the installer to easily verify that all units, by zone, are communicating properly with the Zone Manager.

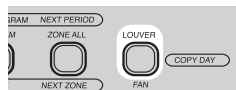

- To enter installation test mode on the Zone Manager, depress and hold the "LOUVER" button down for 5 seconds. When test mode is entered, the display will show zone number and "conf" in place of the system clock.



- The only buttons that are active at this time are "NEXT ZONE" and "END PROGRAM".

The Zone Manager will continuously send out messages to the units in the displayed zone, telling them to flash their protect LED (RED) at a rate of 1 sec on and 1 sec off. The installer can now visually verify that the units in the zone are communicating properly with the Zone Manager.

The "NEXT ZONE" button can be depressed to select a new zone to test. Once the zone is changed, all units in the new zone will start blinking their protect LEDs, assuming addressing and wiring is correct. The previous zone will time out and stop blinking their protect LEDs (RED), after 10 seconds of not receiving a message from the Zone Manager.

The installer should run this test on all zones in the system, verifying that every unit is addressed and wired properly. When complete, the installer can depress the "END PROGRAM" button to disable Installation Test Mode and have the Zone Manager operate normal again.

Once complete, the installer can be confident that the Zone Manager will control all of the zones, based upon each zones' programming information.



Zone Manager

Smart Start function

The purpose of Smart Start is so that the room temperature is at the desired temperature by the time the "ON" period starts. Smart Start is only valid if the period transition is from "OFF" to "ON" in "HEAT", "COOL", or "AUTO" modes; or a "Setback" to "ON" period in "AUTO".

If the Zone Manager has been configured for Smart Start then the following applies, otherwise period transitions will occur on time boundaries.

If the Zone Manager is currently operating in an "OFF" period and the next period is an "ON" period, the following will occur 1.5 hours before the next period is entered.

"OFF" to "ON" period if the operating mode is Heat

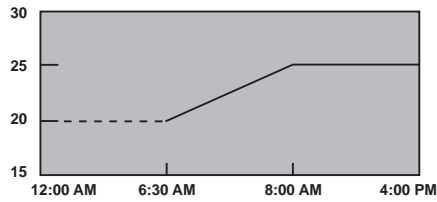

If the operating mode is "HEAT", 1.5 hours before the "ON" period starts, the unit will turn on in Heat mode. The unit will control the room air temperature to the "ON" periods set point minus 5 degrees. The controlling set point will then ramp to the "ON" periods set point.

EXAMPLE OF SMART START FOR HEATING MODE:

TIME	SETPOINT	TYPE OF PERIOD
12:00 am		OFF
8:00 am	25° C	ON

- Unit is off from 12:00 am until 6:30 am.
- The setpoint ramps from 20° C to 25° C from 6:30 am until 8:00 am
- The setpoint remains at 25° C until the next period or the user modifies the setpoint.

OFF to ON period if the operating mode is Cool

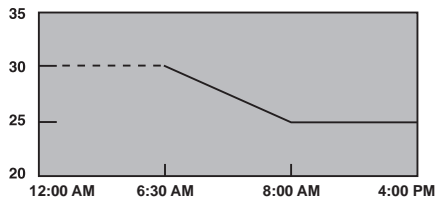

If the operating mode is "cool", 1.5 hours before the "ON" period starts, the unit will turn on in "cool" mode. The unit will control the room air temperature to the "ON" periods setpoint plus 5 degrees. The controlling setpoint will then ramp to the "ON" periods setpoint.

EXAMPLE OF SMART START FOR COOLING MODE:

TIME	SETPOINT	TYPE OF PERIOD
12:00 am		OFF
8:00 am	25° C	ON

- Unit is off from 12:00 am until 6:30 am.
- The setpoint ramps from 30° C to 25° C from 6:30 am until 8:00 am
- The setpoint remains at 25° C until the next period or the user modifies the setpoint.

OFF to ON period if the operating mode is Auto

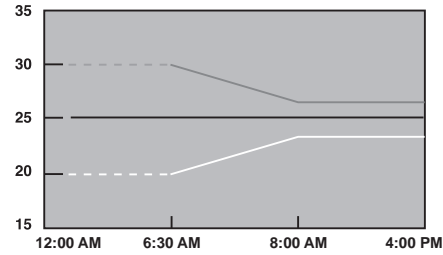

1.5 hours before the "ON" period starts, the unit will turn on in Auto mode.

The unit will control the room air temperature to the "ON" periods setpoint plus or minus the Auto Mode Deadband divided by two.

The controlling setpoints will then ramp towards the "ON" periods setpoint plus or minus two degrees.

EXAMPLE OF SMART START FOR AUTO MODE:

Auto Mode Deadband = 10

TIME	SETPOINT	TYPE OF PERIOD
12:00 am		OFF
8:00 am	25° C	ON

- The unit is off from 12:00 am to 6:30 pm.
- The Heat setpoint ramps from 30° C to 27° C from 6:30 am until 8:00 am.
- The Cool setpoint ramps from 30° C to 27° C from 6:30 am until 8:00 am.

Setback to ON period

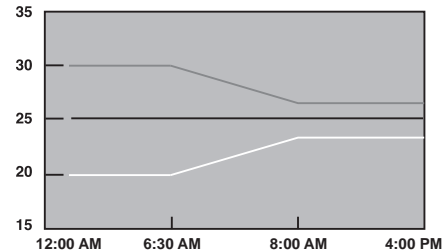

If the Zone Manager is currently operating in a Setback period and the next period is an "ON" period and the setpoint in the Setback period is the same as the setpoint in the "ON" period, the unit will ramp the same as going from an "OFF" period to an "ON" period.

EXAMPLE OF SMART START FOR AUTO MODE:

Auto Mode Deadband = 10

TIME	SETPOINT	TYPE OF PERIOD
12:00 am	25° C	SETBACK
8:00 am	25° C	ON

- The Heat setpoint is 20° C and the Cool setpoint is 30° C from 12:00 am to 6:30 pm.
- The Heat setpoint ramps from 20° C to 23° C from 6:30 am until 8:00 am.
- The Cool setpoint ramps from 30° C to 27° C from 6:30 am until 8:00 am.

If the Zone Manager is currently operating in a Setback period and the next period is an "ON" period with a different setpoint, the following will occur 1.5 hours before the next period is entered.

1.5 hours before the "ON" period starts Smart Start is activated. The unit will control the room air temperature to the Setback periods setpoint plus or minus the Auto Mode Deadband divided by two and ramp towards the "ON" periods setpoint plus or minus two degrees.

Zone Manager

Trouble Shooting

Symptom	Possible Cause	Things to check	Solution
No LCD display	1) mis-wiring of the 12 volt power to Zone Manager control.	1) Verify that +12 v and Gnd are connected to the proper terminals of the Zone Manager control and the COM board. Reference Installation wiring section for correct connections 2) Check pin connections of Zone Manager to base plate terminal block while closing the plastic.	After disconnecting the power, correct the wiring problem and re-cycle power.
	2) Power not online	1) Check that the units main power is connected. The main control board should be operating normally	After verifying the wiring to the Zone Manager control, re-cycle the unit power.
	3) No 12 volts on +12 and GND of terminal block..	1) Check the installation of the COM board. Check to see that the 9 pin connection of the COM board to main board is correct.	After disconnecting the power, correct the wiring problem and re-cycle power.
+12 volts applied to CZM at the correct terminals and still does not operate	1) Make sure the cable connections are correct 2) The Zone Manager control is damaged.		Verify wiring did not damage the Zone Manager. Change the Zone Manager control and re-cycle power.

System errors

System does not Heat/Cool	<p>1) If diagnostic code is displayed, check diagnostic trouble shooting table.</p> <p>2) Put the zone manager into "Installation Test" mode and check unit's LED to blink rapidly.</p> <p style="padding-left: 40px;">If the unit's LED does not blink:</p> <ol style="list-style-type: none"> 1) Configure unit for the proper zone and re-try "Installation Test". 2) Check communication wiring. 3) Check prime board installation.
	<p>3) Select Heat/Cool mode. Adjust the set point so that there is a real heating or cooling request.</p> <p>Wait for unit's time guard to expire. If unit does not operate, check unit for errors. If unit does operate, Check the Zone Managers programming for scheduling errors.</p>

Diagnostic errors

Displayed error "A2"	<p>Temperature sensor error! Check temperature sensor for damage. If recycling power does not clear display, replace the Zone Manager.</p>
Displayed error "Cx" Where x is a number identifying a zone.	<p>Communication error with unit(s) in zone (x)!</p> <p>1) Put the zone manager into "Installation Test" mode and check unit(s) LED to blink rapidly.</p> <p style="padding-left: 40px;">If the units LED does not blink:</p> <ol style="list-style-type: none"> 1) Configure unit for the proper zone and re-try "COMM" mode. 2) Check communication wiring 3) Check prime board installation.
Displayed error "Fx" Where x is a number identifying a zone.	<p>Unit(s) in zone (x) has recorded a failure! 1) go to the unit(s) in zone (x) and determine the cause of the failure.</p>



Via R. Sanzio, 9 - 20058 Villasanta (MI) Italy - Tel. 039/3636.1

The manufacturer reserves the right to change any product specifications without notice.