

# Service Manual

## AIR CONDITIONER



Supplement

CS-A24BD1P CU-A24BBP5  
 CS-A28BD1P CU-A28BBP5  
 CS-A28BD1P CU-A28BBP8  
 CS-A34BD1P CU-A34BBP5  
 CS-A34BD1P CU-A34BBP8  
 CS-A43BD1P CU-A43BBP8  
 CS-A50BD1P CU-A50BBP8

**Subject :** Correction in Specification (Heat Pump Type), Fan Performance, Component Specification, Sound Data, and Indoor Unit Replacement Parts.

Please file and use this supplement manual together with the service manual for Model No. CS-A24BD1P/CU-A24BBP5, CS-A28BD1P/CU-A28BBP5, CS-A28BD1P/CU-A28BBP8, CS-A34BD1P/CU-A34BBP5, CS-A34BD1P/CU-A34BBP8, CS-A43BD1P/CU-A43BBP8, CS-A50BD1P/CU-A50BBP8, Order No. MAC0112090C0.

### WARNING

This service information is designed for experienced repair technicians only and is not designed for use by the general public. It does not contain warnings or cautions to advise non-technical individuals of potential dangers in attempting to service a product. Products powered by electricity should be serviced or repaired only by experienced professional technicians. Any attempt to service or repair the product or products dealt with in this service information by anyone else could result in serious injury or death.

## CONTENTS

	Page		Page
1 SPECIFICATION (HEAT PUMP TYPE) (Pages: 7 ~ 13) .....	2	4 SOUND DATA (Pages: 55 ~ 57) .....	7
2 FAN PERFORMANCE (Pages: 41 ~ 44) .....	3	5 REPLACEMENT PARTS (Pages: 112 ~ 113) .....	10
3 COMPONENT SPECIFICATION (Page: 46) .....	6		

# 1 SPECIFICATION (HEAT PUMP TYPE) (Pages: 7 ~ 13)

## 1.1 CS-A24BD1P / CU-A24BBP5

ITEM / MODEL		Indoor Unit	Outdoor unit
		Main Body	CS-A24BD1P
External Static Pressure	Pa mmAq	Hi 98 Me 74 Lo 59 Hi 10 Me 7.5 Lo 6	-

## 1.2 CS-A28BD1P / CU-A28BBP5

ITEM / MODEL		Indoor Unit	Outdoor unit
		Main Body	CS-A28BD1P
External Static Pressure	Pa mmAq	Hi 98 Me 74 Lo 59 Hi 10 Me 7.5 Lo 6	-

## 1.3 CS-A28BD1P / CU-A28BBP8

ITEM / MODEL		Indoor Unit	Outdoor unit
		Main Body	CS-A28BD1P
External Static Pressure	Pa mmAq	Hi 98 Me 74 Lo 59 Hi 10 Me 7.5 Lo 6	-

## 1.4 CS-A34BD1P / CU-A34BBP5

ITEM / MODEL		Indoor Unit	Outdoor unit
		Main Body	CS-A34BD1P
External Static Pressure	Pa mmAq	Hi 98 Me 74 Lo 59 Hi 10 Me 7.5 Lo 6	-

## 1.5 CS-A34BD1P / CU-A34BBP8

ITEM / MODEL		Indoor Unit	Outdoor unit
		Main Body	CS-A34BD1P
External Static Pressure	Pa mmAq	Hi 98 Me 74 Lo 59 Hi 10 Me 7.5 Lo 6	-

## 1.6 CS-A43BD1P / CU-A43BBP8

ITEM / MODEL		Indoor Unit	Outdoor unit
		Main Body	CS-A43BD1P
External Static Pressure	Pa mmAq	Hi 98 Me 74 Lo 59 Hi 10 Me 7.5 Lo 6	-

## 1.7 CS-A50BD1P / CU-A50BBP8

ITEM / MODEL		Indoor Unit	Outdoor unit
		Main Body	CS-A50BD1P
External Static Pressure	Pa mmAq	Hi 98 Me 74 Lo 59 Hi 10 Me 7.5 Lo 6	-

# 2 FAN PERFORMANCE (Pages: 41 ~ 44)

## Fan Performance Test Report

Model	External static pressure Pa (mmAq)	Fan speed	Current (A)	Power consumption (kW)	RPM (r/m)	Air volume (m <sup>3</sup> /min)
CS-A24BD1P	98 (10)	Hi	0.87	0.17	1402	20.0
	74 (7.5)	Me	0.55	0.12	1290	16.0
	59 (6)	Lo	0.51	0.10	1188	15.0
CS-A28BD1P	98 (10)	Hi	1.22	0.30	1176	30.0
	74 (7.5)	Me	0.94	0.13	983	25.5
	59 (6)	Lo	0.73	0.17	807	20.5
CS-A34BD1P	98 (10)	Hi	2.82	666	1280	40.0
	74 (7.5)	Me	2.19	526	1090	33.5
	59 (6)	Lo	1.75	408	880	25.5
CS-A43BD1P	98 (10)	Hi	1.66	0.39	1380	50.0
	74 (7.5)	Me	1.30	0.31	1270	42.5
	59 (6)	Lo	1.17	0.29	1030	34.5
CS-A50BD1P	98 (10)	Hi	2.82	666	1280	60.0
	74 (7.5)	Me	2.19	526	1090	52.5
	59 (6)	Lo	1.75	408	880	47.0

### ● CS-A24BD1P

#### Fan Performance Curve

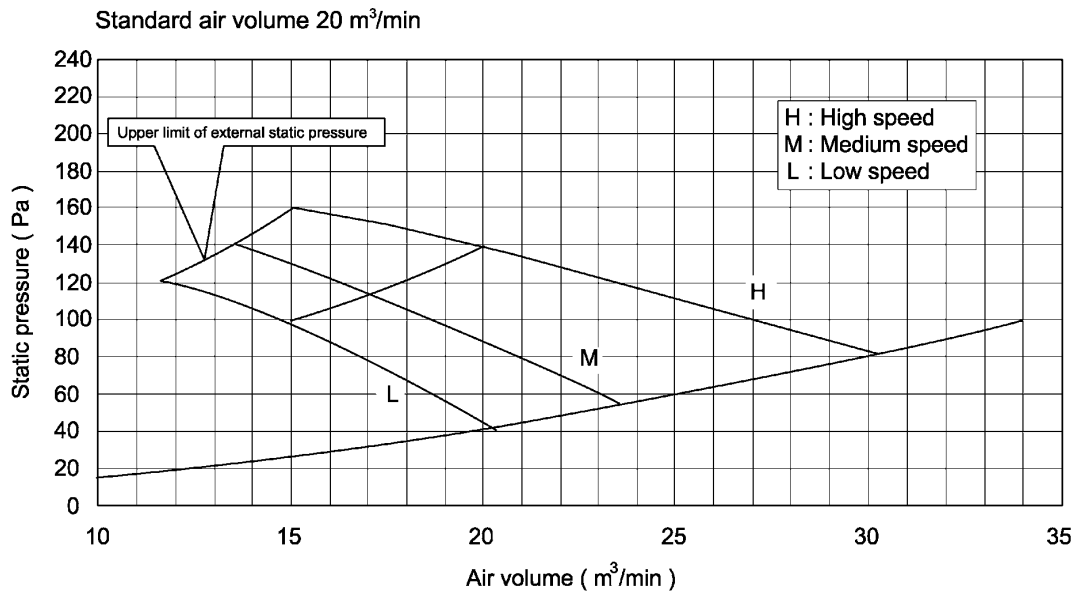

#### Coefficient For Correcting Cooling Capacity

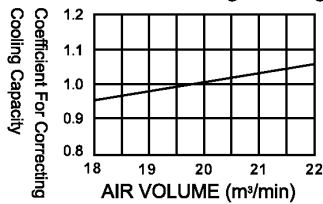

#### Coefficient For Correcting Heating Capacity

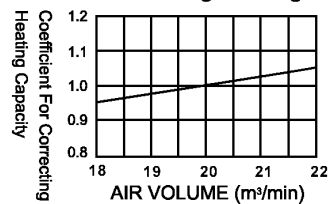

● CS-A28BD1P

Fan Performance Curve

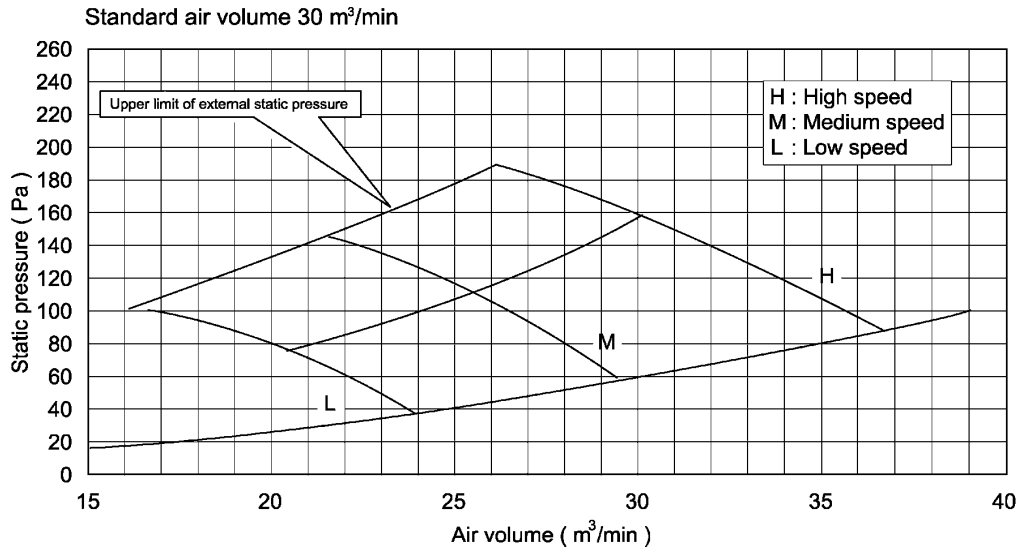

Coefficient For Correcting Cooling Capacity

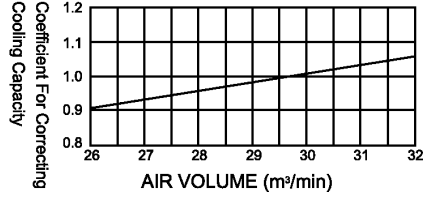

Coefficient For Correcting Heating Capacity

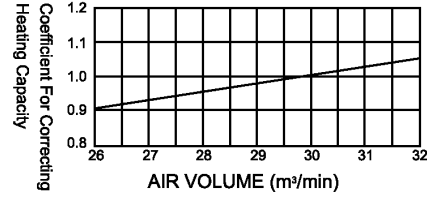

● CS-A34BD1P

Fan Performance Curve

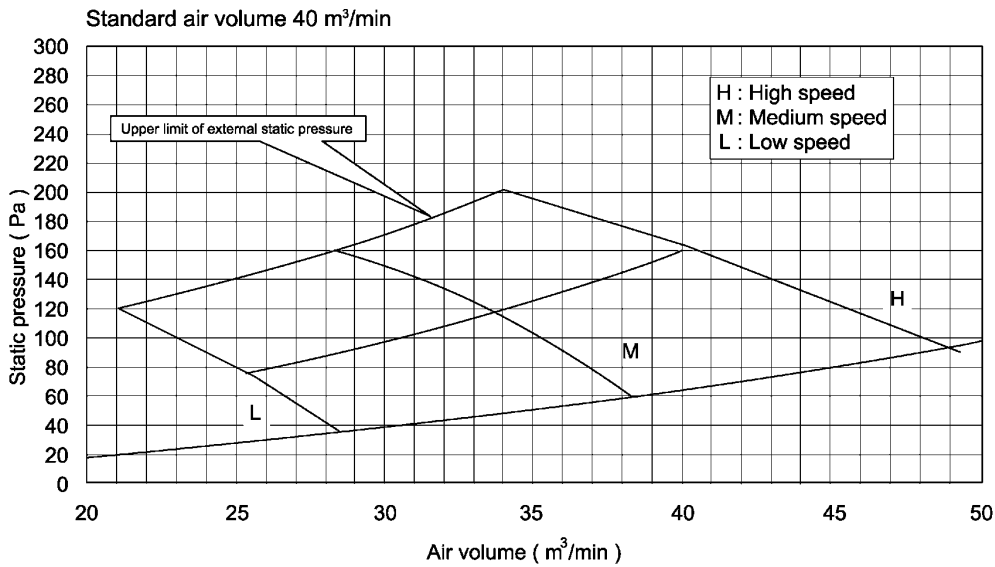

Coefficient For Correcting Cooling Capacity

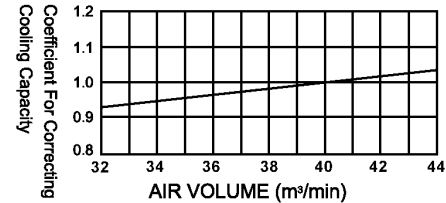

Coefficient For Correcting Heating Capacity

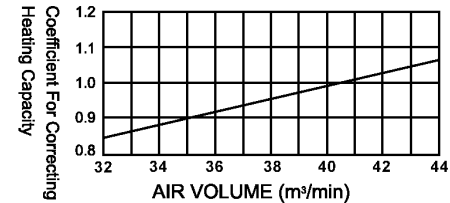

● CS-A43BD1P

Fan Performance Curve

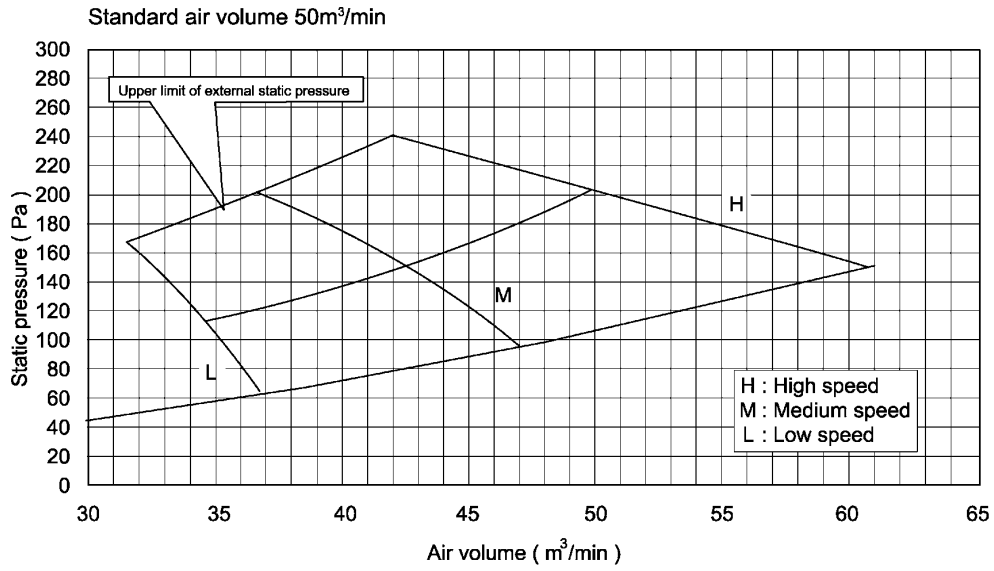

Coefficient For Correcting Cooling Capacity

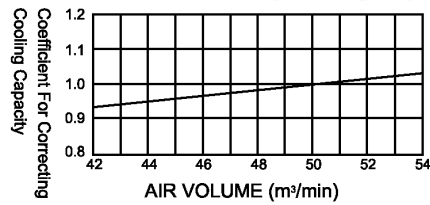

Coefficient For Correcting Heating Capacity

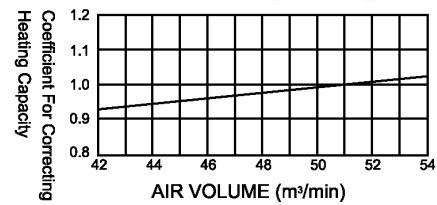

● CS-A50BD1P

Fan Performance Curve

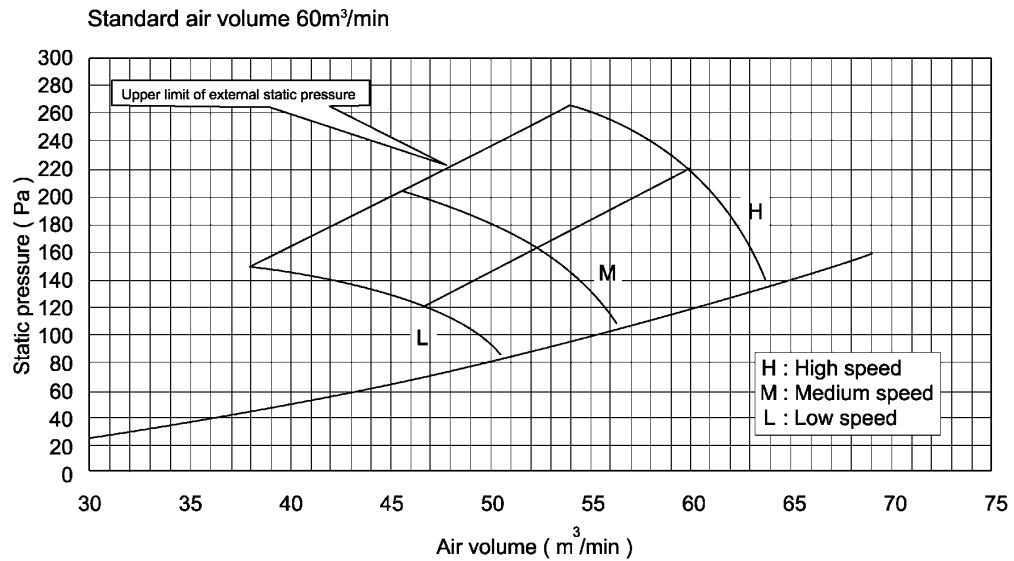

Coefficient For Correcting Cooling Capacity

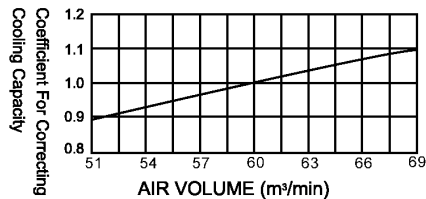

Coefficient For Correcting Heating Capacity

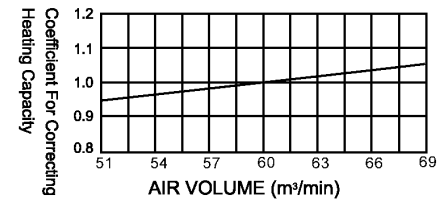

### 3 COMPONENT SPECIFICATION (Page: 46)

#### Compressor

Model	Heat pump model	50Hz	CU-A24BBP5	CU-A28BBP5 CU-A28BBP8	CU-A34BBP5 CU-A34BBP8	CU-A43BBP8	CU-A50BBP8
Compressor Model			NE41VNDT	NE44VNDT NH44YDET	ZR45KC-TFD ZR45KC-TF5	ZR57KC-TFD ZR57KC-TF5	ZR-68KC-TFD ZR-68KC-TFD

# 4 SOUND DATA (Pages: 55 ~ 57)

CS-A24BD1P

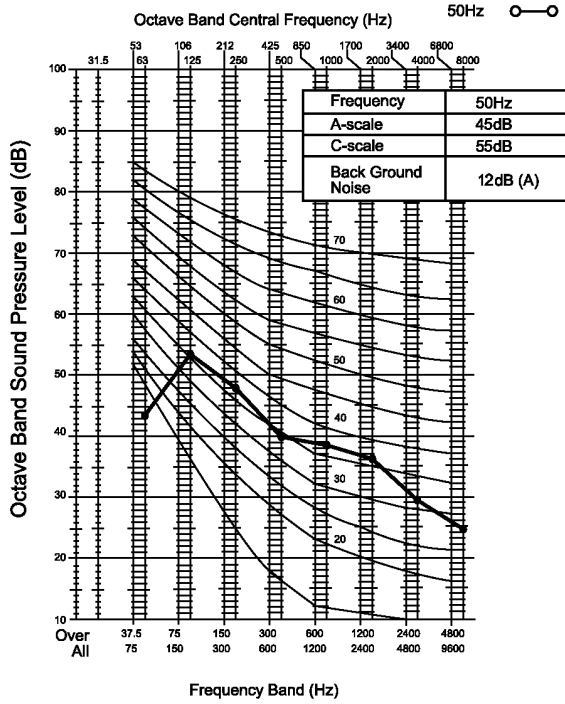

CU-A24BBP5

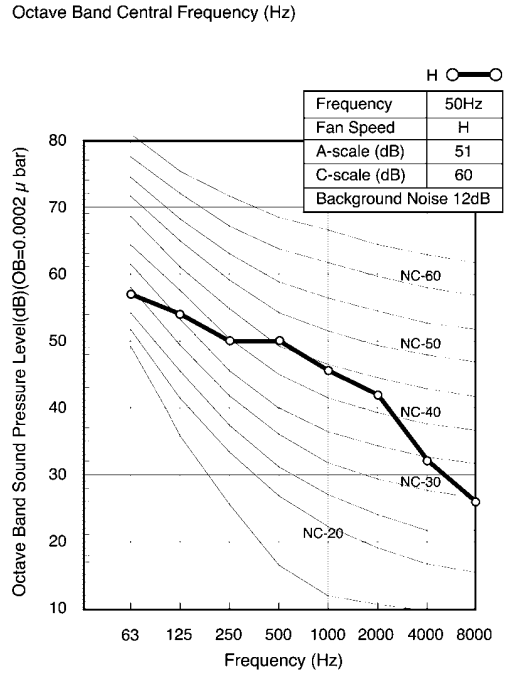

CS-A28BD1P

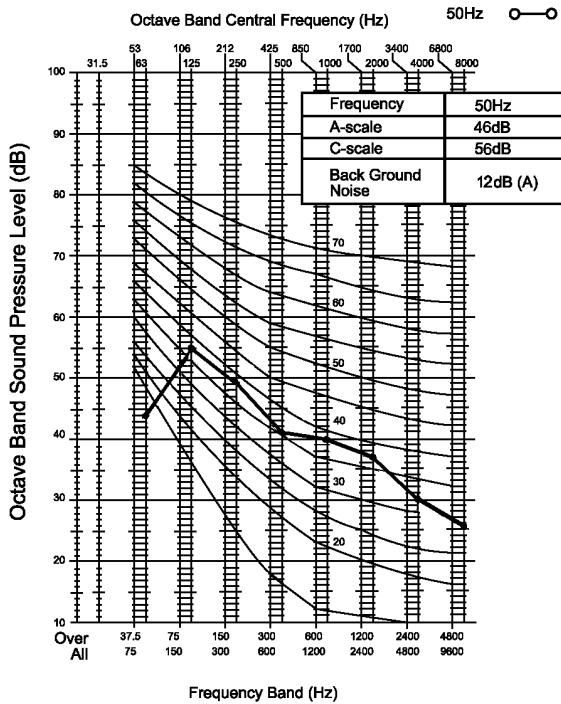

CU-A28BBP5, CU-A28BBP8

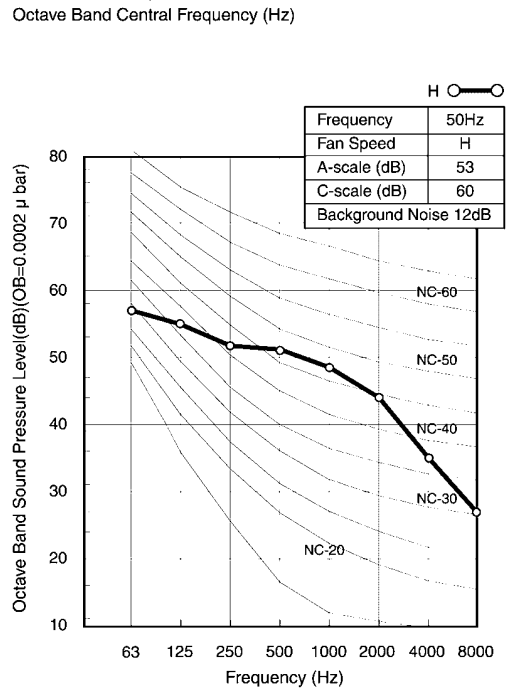

Note:  
:Microphone Position

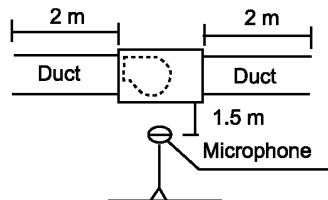

**CS-A34BD1P**

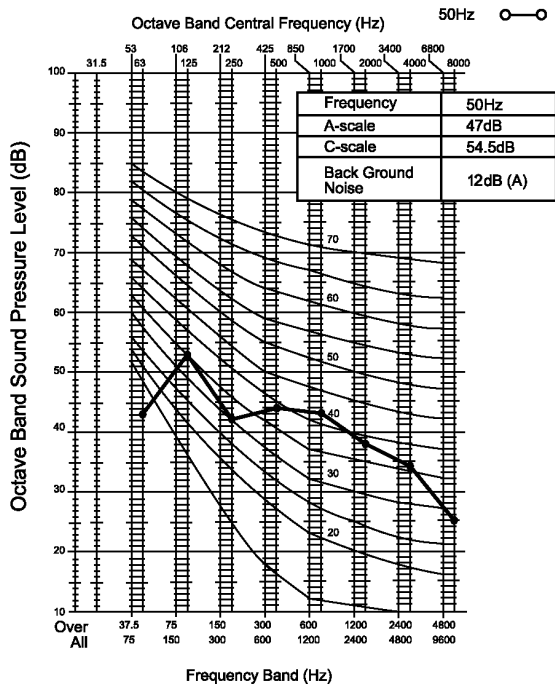

**CU-A34BBP5, CU-A34BBP8**

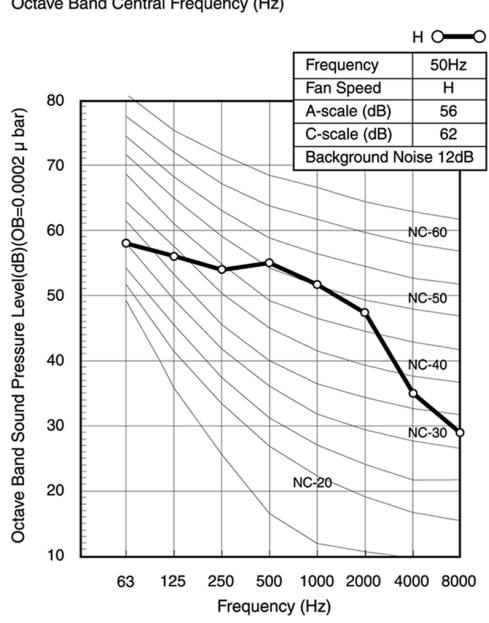

**CS-A43BD1P**

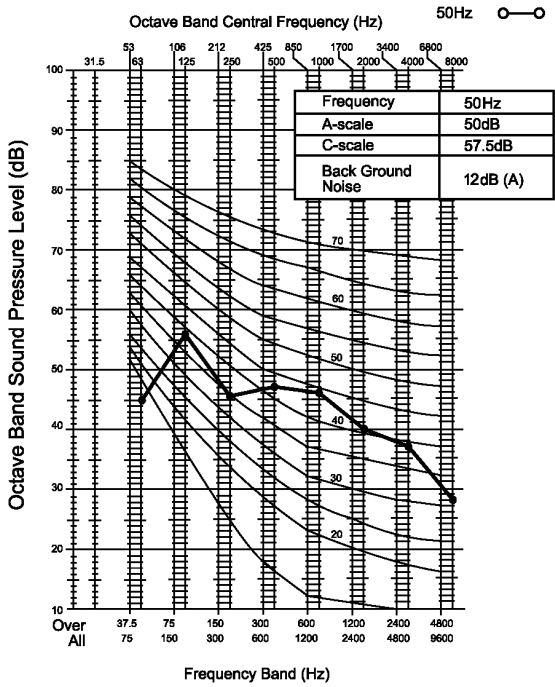

**CU-A43BBP8**

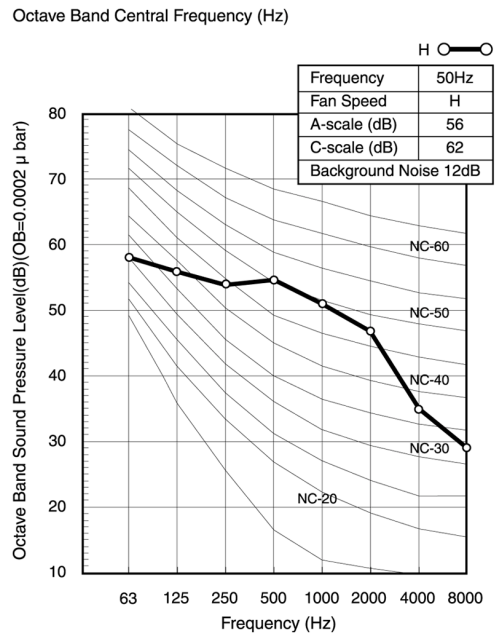



CS-A50BD1P

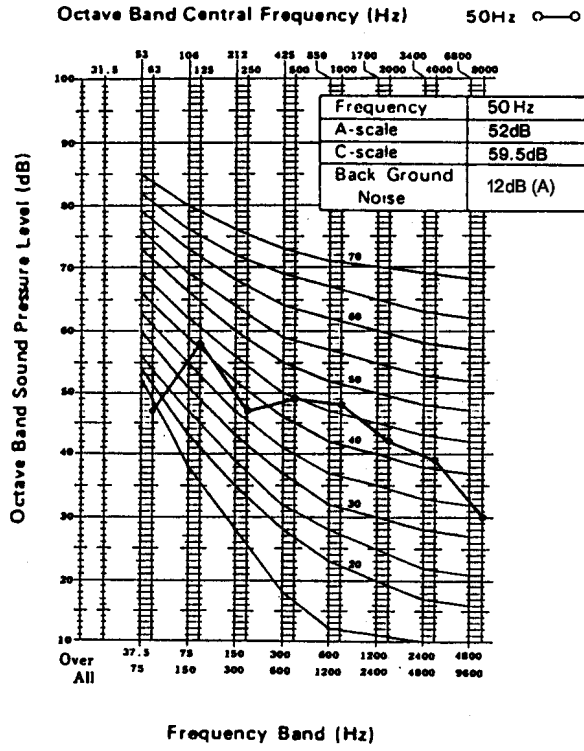

CU-A50BBP8

Octave Band Central Frequency (Hz)

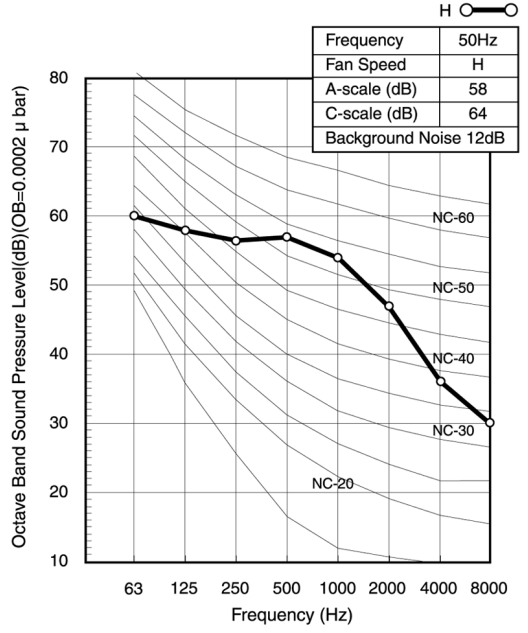

NOTE:

: Microphone Position

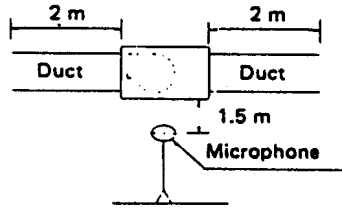

# 5 REPLACEMENT PARTS (Pages: 112 ~ 113)

## 5.1. INDOOR UNIT

CS-A24BD1P, CS-A28BD1P, CS-A34BD1P, CS-A43BD1P, CS-A50BD1P

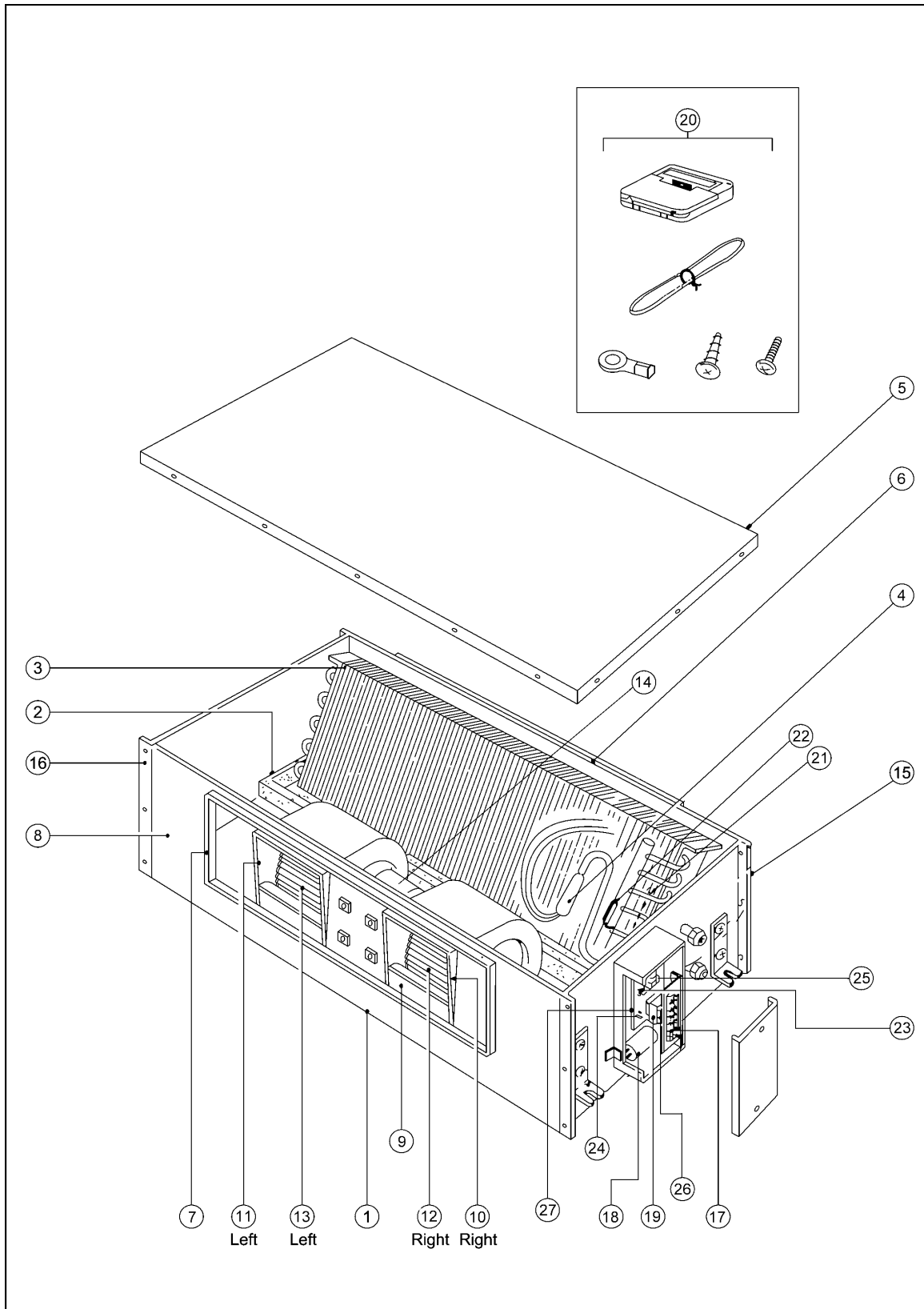

NO.	PART DESCRIPTION	QTY.	CS-A24BD1P	CS-A28BD1P	CS-A34BD1P	CS-A43BD1P	CS-A50BD1P
27	WIRE HARNESS ASS'Y IHA	1	P46-T04000	←	←	←	←

All parts are supplied by Taiwan (Tamaco).