

## 5. Block Diagrams

### 5-1 Refrigerating Cycle Block Diagram

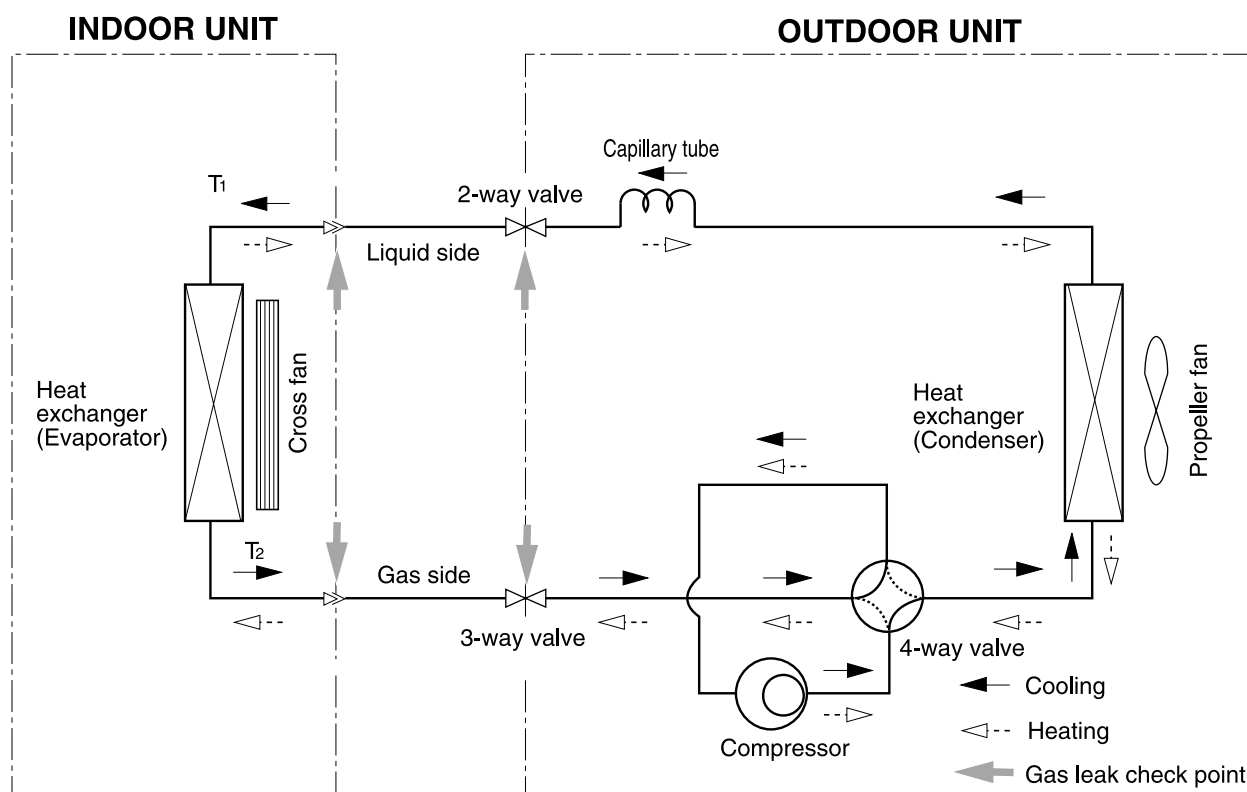

## 6. PCB Diagrams

### 6-1 MAIN PCB (AC) : DB93-01324C

■ TOP

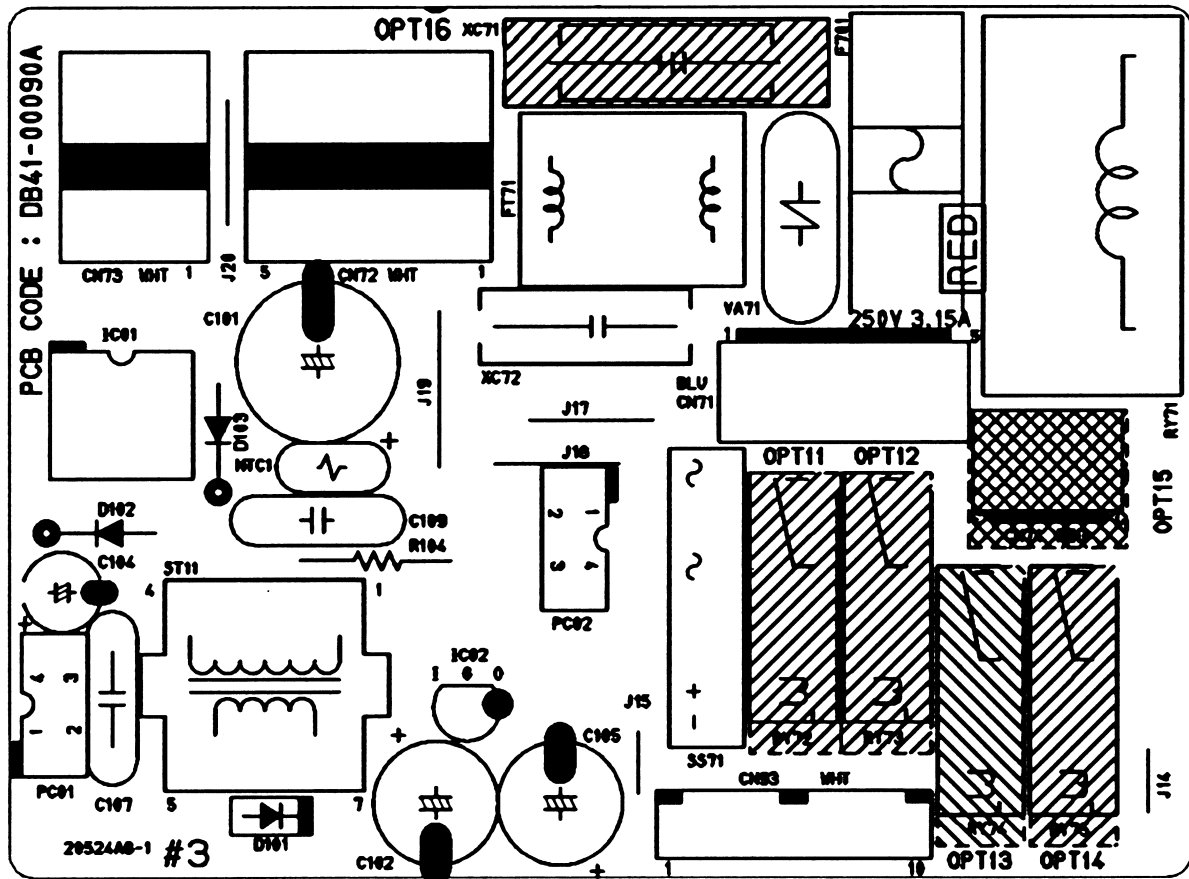

	OPT11	OPT12	OPT13	OPT14	OPT15	OPT16 (XC71)
DB93-01324A	○	○	×	×	×	220nF/250V
DB93-01324B	×	×	×	×	×	220nF/250V
DB93-01324C	○	○	○	×	○	220nF/250V
DB93-01324D	○	×	○	×	○	220nF/250V
DB93-01324E	○	○	○	○	○	220nF/250V
DB93-01324F	○	×	○	○	○	220nF/250V

## ■ Parts List

No	Location No.	Description	Specification	Q'TY	Remark
1	C101	C-AL	10uF,20%,450V,GP,TP,10x20mm,5	1	SNA
2	C102	C-AL	470uF,20%,25V,GP,TP,10x16,5	1	SNA
3	C104	C-AL	47uF,20%,50V,GP,TP,6.3x11,5	1	SNA
4	C105	C-AL	470uF,20%,16V,GP,TP,10x12.5,5	1	SNA
5	C107	C-CERAMIC,DISC	2.2nF,20%,400V,Y5U,TP,12.5x6,10	1	SNA
6	C109	C-CERAMIC,DISC	100nF,20%,1KV,TP,6	1	SNA
7	XC71	C-FILM,MPEF	220NF,10%,275V,BK,26.5x8.5x17MM,22.5	1	SNA
8	XC72	C-FILM,MPEF	100nF,10%,275V,BK,18x6x12,15	1	SNA
9	FT71	CHOKE-COIL	LS404190M,AS-S660,19MH,+50,-30%,-,300MOHM,2A,-,-,	1	SNA
10	CN71	CONNECTOR-HEADER	1WALL,3P/5P,1R,3.96mm,STRAIGHT,SN	1	SNA
11	CN72	CONNECTOR-HEADER	1WALL,5P,1R,3.96mm,ANGLE,SN	1	SNA
12	CN73	CONNECTOR-HEADER	1WALL,2P/3P,1R,3.96mm,ANGLE,SN	1	SNA
13	CN74	CONNECTOR-HEADER	1WALL,3P,1R,3.96mm,STRAIGHT,SN	1	SNA
14	CN93	CONNECTOR-HEADER	BOX,10P,1R,-,STRAIGHT,SN	1	SNA
15	D101	DIODE-RECTIFIER	UG2D,200V,2A,DO-204AC,TP	1	SNA
16	D103	DIODE-RECTIFIER	UF4007,1KV,1A,DO-41,TP	1	SNA
17	D102	DIODE-SWITCHING	1N4148,100V,200mA,DO-35,TP	1	SNA
18	F701	FUSE-CARTRIDGE	250V,3.15A,TIME-LAG,GLASS,5x20mm	1	SNA
19	IC01	IC-PWM CONTROLLER	VIPER12ADIP,DIP,8P,300MIL,PLASTIC	1	SNA
20	IC02	IC-VOLT REGU	78L05A,TO-92,3P,-,PLASTIC,4.6/	1	SNA
21	PC01	PHOTO-COUPLER	TR,130-260%,200mW,DIP-4,ST	1	SNA
22	PC02	PHOTO-COUPLER	TR,50-150%,200mW,DIP-4,ST	1	SNA
23	RY72,RY73,RY74,RY75	RELAY-MINIATURE	DC12V,3A 250V AC,-,-,10MS,10MS	3	SNA
24	RY71	RELAY-POWER	12VDC,0.9W,75mA,SPST,MAX 20msec,10mS	1	SNA
25	R104	R-METAL OXIDE(S)	91Kohm,5%,2W,AA,TP,4x12mm	1	SNA
26	SS71	SSR	12Vdc,-,2A,1mS,1mS	1	SNA
27	NTC1	THERMISTOR-NTC	22ohm,1.4A,3100K,9.5MW/C,-,7.0,-	1	SNA
28	ST11	TRANS	S/W TRANS:-,G-P/J,EE1916-V10,-,-,-	1	SNA
29	VA71	VARISTOR	560V,2500A,17.5x7.5mm,TP	1	SNA

■ BOTTOM

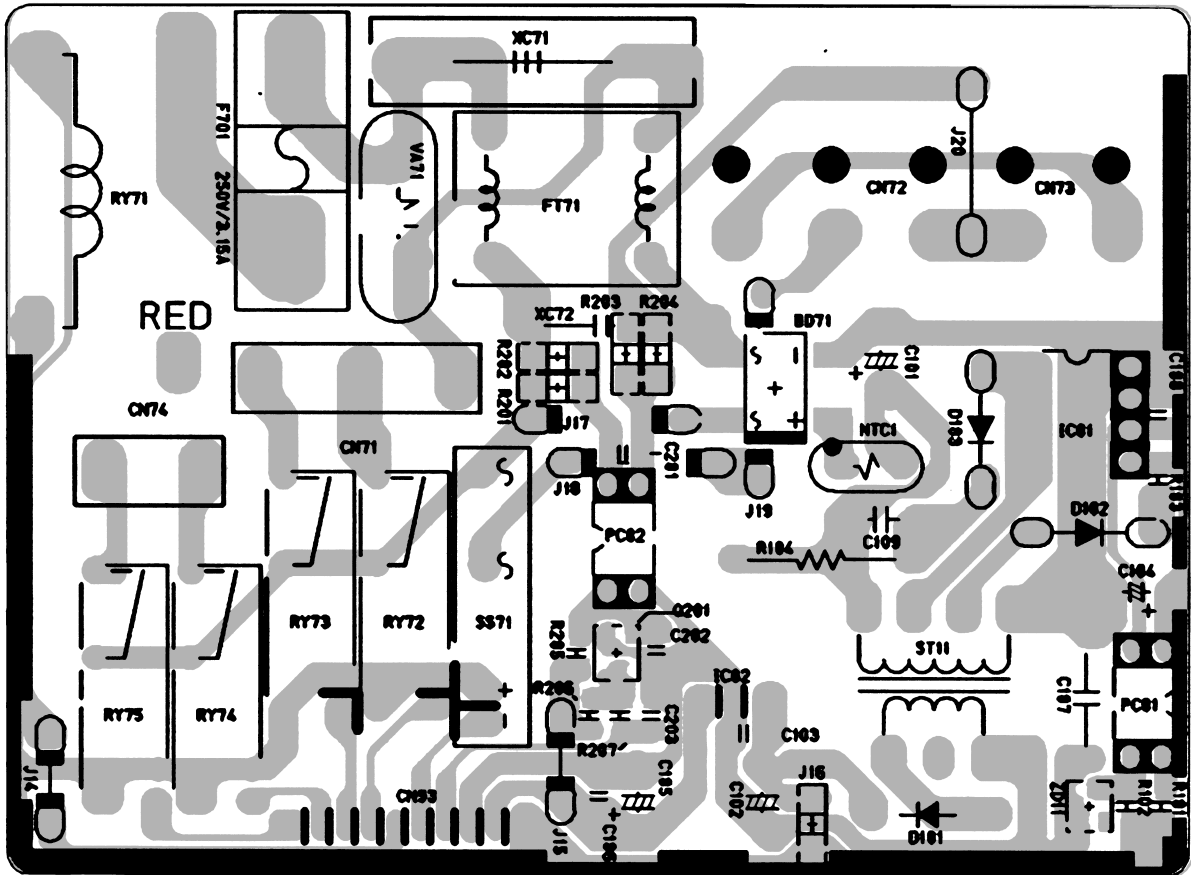

■ Parts List

No	Location No.	Description	Specification	Q'TY	Remark
1	BD71	DIODE-BRIDGE	DF06S,600V,1A,SMD-4,TP	1	SNA
2	C103,C106,C108,C201	C-CERAMIC,CHIP	100nF,+80-20%,50V,Y5V,TP,2012,	4	SNA
3	C202,C203	C-CERAMIC,CHIP	10nF,+80-20%,50V,Y5V,TP,2012	2	SNA
4	Q201	TR-SMALL SIGNAL	2SC2412K,NPN,200mW,SOT-23,TP,1	1	SNA
5	R101	R-CHIP	100ohm,5%,1/10W,DA,TP,2012	1	SNA
6	R102	R-CHIP	2.2Kohm,5%,1/10W,DA,TP,2012	1	SNA
7	R103	R-CHIP	6.8ohm,5%,1/10W,DA,TP,2012	1	SNA
8	R201,R202,R203,R204	R-CHIP	100Kohm,5%,1/4W,DA,TP,3216	4	SNA
9	R205	R-CHIP	10Kohm,5%,1/10W,DA,TP,2012	1	SNA
10	R206,R207	R-CHIP	1Kohm,5%,1/10W,DA,TP,2012	2	SNA
11	ZD11	DIODE-ZENER	BZX84-C11,10.4-11.6V,350MW,SOT-23,TP	1	SNA

# 6-2 MAIN PCB (DC) : DB93-01325F

■ TOP

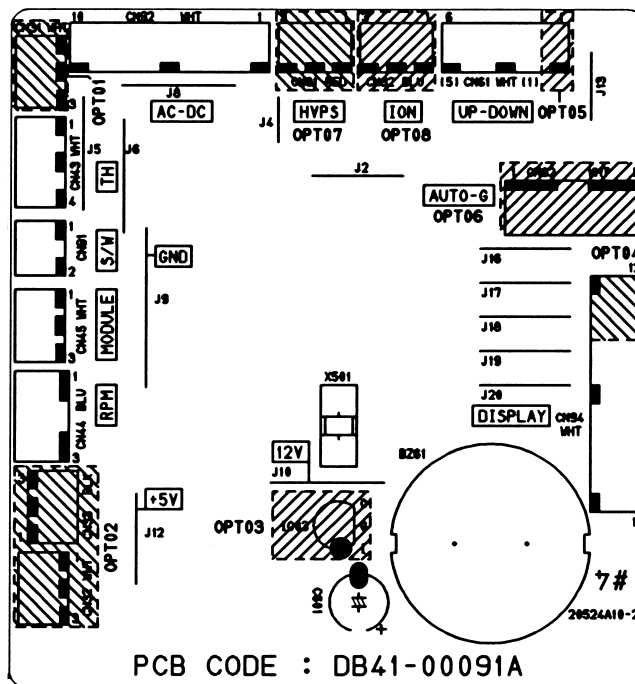

ASS'Y PCB	OPT01	OPT02	OPT03	OPT04 (CN94)	OPT05 (CN61)	OPT06	OPT07	OPT08
DB93-01325A	x	x	x	SMW200-09(WHT)	SMW200-05(WHT)	x	x	x
DB93-01325B	x	x	x	SMW200-12(WHT)	SMW200-05(WHT)	o	x	o
DB93-01325C	x	x	x	SMW200-12(WHT)	SMW200-05(WHT)	o	o	o
DB93-01325E	x	x	x	SMW200-09(WHT)	SMW200-06(WHT)	x	x	x
DB93-01325F	x	x	x	SMW200-12(WHT)	SMW200-06(WHT)	o	x	o
DB93-01325G	x	x	x	SMW200-12(WHT)	SMW200-06(WHT)	o	o	o
DB93-01325J	x	x	x	SMW200-12(WHT)	SMW200-05(WHT)	o	o	x
DB93-01325K	x	x	x	SMW200-12(WHT)	SMW200-05(WHT)	o	x	x
DB93-01325L	x	x	x	SMW200-12(WHT)	SMW200-06(WHT)	o	o	x

## ■ Parts List

No	Location No.	Description	Specification	Q'TY	Remark
1	BZ61	BUZZER-PIEZO	BUZZER-PIEZO;80DB,9V ,-,2.0KHZ,-	1	SNA
2	X501	RESONATOR-CERAMIC	10MHz,0.5%,TP,10.0x5.0x8.0mm	1	SNA
3	C601	C-AL	47uF,20%,50V,GP,TP,6.3x11,5	1	SNA
4	CN31	CONNECTOR-HEADER	BOX,3P,1R,2MM,STRAIGHT,SN	1	SNA
5	CN32	CONNECTOR-HEADER	BOX,3P,1R,2MM,STRAIGHT,SN	1	SNA
6	CN33	CONNECTOR-HEADER	BOX,3P,1R,2MM,STRAIGHT,SN	1	SNA
7	CN43	CONNECTOR-HEADER	BOX,4P,1R,2MM,STRAIGHT,SN	1	SNA
8	CN44	CONNECTOR-HEADER	BOX,3P,1R,2.5mm,STRAIGHT,SN	1	SNA
9	CN45	CONNECTOR-HEADER	BOX,3P,1R,2MM,STRAIGHT,SN	1	SNA
10	CN61	CONNECTOR-HEADER	BOX,5P,1R,2MM,STRAIGHT,SN	1	SNA
11	CN62	CONNECTOR-HEADER	BOX,5P,1R,2.5mm,STRAIGHT,SN	1	SNA
12	CN81	CONNECTOR-HEADER	BOX,3P,1R,2MM,STRAIGHT,SN,RED	1	SNA
13	CN82	CONNECTOR-HEADER	BOX,3P,1R,2MM,STRAIGHT,SN,BLU	1	SNA
14	CN91	CONNECTOR-HEADER	BOX,2P,1R,2mm,STRAIGHT,SN	1	SNA
15	CN92	CONNECTOR-HEADER	BOX,10P,1R,-,STRAIGHT,SN	1	SNA
16	CN94	CONNECTOR-HEADER	BOX,12P,1R,2mm,STRAIGHT,SN	1	SNA
17	IC03	IC-VOLTAGE	7533,TO-92,3P,-,SINGLE,-,-,PLA	-	SNA

■ BOTTOM

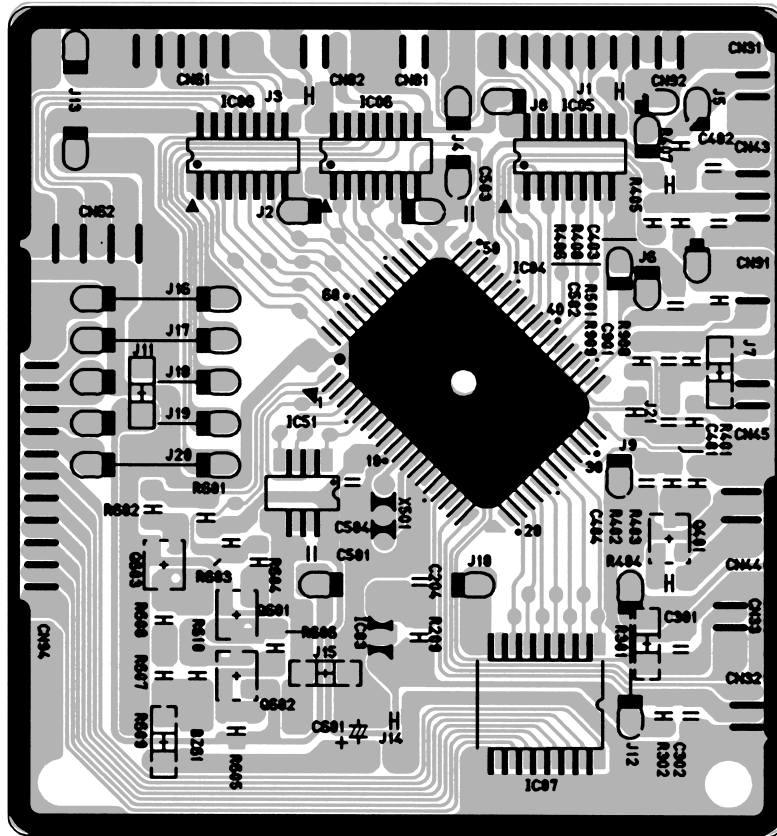

■ Parts List

No	Location No.	Description	Specification	Q'TY	Remark
1	C204,C301,C302,C402,C403 C501,C502,C503,C504,C901	C-CERAMIC,CHIP	100nF,+80-20%,50V,Y5V,TP,2012	10	SNA
2	C401	C-CERAMIC,CHIP	1nF,10%,50V,X7R,TP,2012,-	1	SNA
3	C404	C-CERAMIC,CHIP	10nF,+80-20%,50V,Y5V,TP,2012	1	SNA
4	IC04	IC-MICOM	S3C8489XZZ-QTR5,-,64,+5V,10MHZ,STM-0219-O	1	SNA
5	IC05,IC06,IC08	TR-ARRAY	2003,NPN,7,1W,SOP-16,ST,1000	3	SNA
6	IC07	IC-SOURCE DRIVER	TD62783AFW,SOL,18P,-,8,-500MA,TP,	1	SNA
7	IC51	IC-EEPROM	93LC56,128x16Bit,SOP,8P,150MIL,-,2.5V,-,	1	SNA
8	Q401,Q601,Q603	TR-SMALL SIGNAL	2SC2412K,NPN,200mW,SOT-23,TP,1	3	SNA
9	Q602	TR-SMALL SIGNAL	MMST2907A,PNP,200mW,SOT-23,TP,100-	1	SNA
10	R209,R301,R302,R401,R402 R404,R602,R604,R610	R-CHIP	1Kohm,5%,1/10W,DA,TP,2012	9	SNA
11	R403,R407,R408	R-CHIP	6.8Kohm,5%,1/10W,DA,TP,2012	3	SNA
12	R405,R406	R-CHIP	330ohm,5%,1/10W,DA,TP,2012	2	SNA
13	R501,R601,R603,R605,R908	R-CHIP	10Kohm,5%,1/10W,DA,TP,2012	5	SNA
14	R606,R909	R-CHIP	4.7Kohm,5%,1/10W,DA,TP,2012	2	SNA
15	R607,R608	R-CHIP	470ohm,5%,1/10W,DA,TP,2012	2	SNA
16	R609	R-CHIP	560ohm,5%,1/10W,DA,TP,2012	1	SNA

## 6-3 ASS'Y DISPLAY PCB

■ 24K/18K : DB93-01368\*

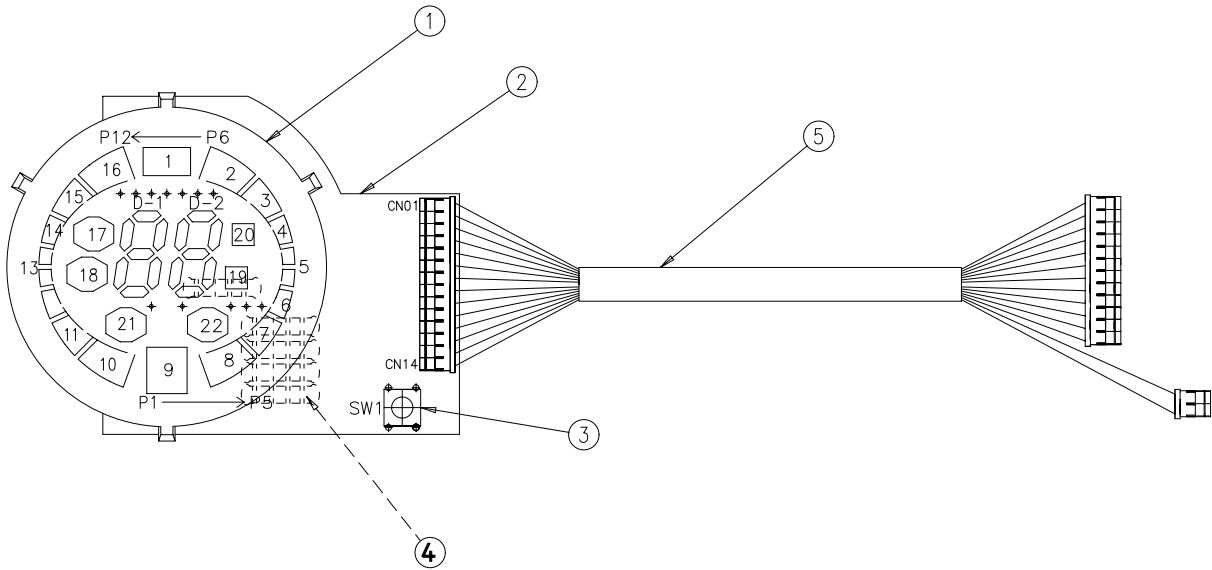

Code No.	Model Name	Remark
DB93-01368C	AQ(T)**P*G*	
DB93-01368D	SH24TP6/SH18ZP0	

### ■ Parts List

No	Description	Specification	Q'TY	Remark
1	ASSY LED MODULE		1	SNA
2	PCB-DISPLAY	FR-1 T1.6	1	SNA
3	TACT SWITCH	KPT-1105A	1	SNA
4	RESISTOR	200ohm, 2W	5	SNA
5	CONNECTOR WIRE	14P	1	SNA

## 6-4 ASS'Y MODULE PCB : DB93-01369B

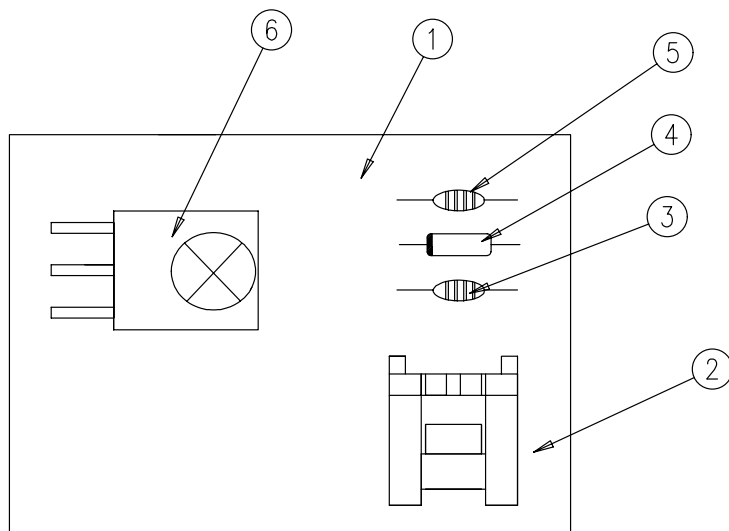

### ■ Parts List

No	Description	Specification	Q'TY	Remark
1	PCB MODULE	FR1 T1.6	1	SNA
2	CONNECTOR-HEADER	BOX, 3P, 1R, 2mm, ANGLE, SN	1	SNA
3	C-CERAMIC, MLC-AXIAL	1nF, 10%, 50V, Y5P, TP, 1.9 x 3.5, -	1	SNA
4	DIODE-SWITCHING	1N4148, 100V, 200mA, DO-35, TP	1	SNA
5	C-CERAMIC, MLC-AXIAL	100nF, +80-20%, 50V, Y5V, TP, 3.5 x 1	1	SNA
6	MODULE	FRP4021H7	1	SNA