

## 6. Trouble Shooting

### ■ Trouble shooting by outdoor unit error code

ERROR CODE	ERROR DESCRIPTION	REFERENCE PART
E1	Indoor unit room thermistor error	EC01
E5	Indoor unit pipe thermistor error	EC02
E6	Outdoor unit thermistor error	EC03
E9	Float switch open error	EC04
EA	Communication error between indoor unit and outdoor unit	EC05
EC	Communication error between wired remote controller and indoor unit	EC06
ED	Outdoor unit pipe thermistor error	EC07

### ■ Trouble shooting by indoor unit receive board

ERROR CODE	ERROR CODE	REFERENCE PART
Reservation LED flickering(1Hz period)	Indoor temperature sensor abnormal	EC01
Operation LED and reservation LED flickering (1Hz period)	Indoor pipe temperature sensor abnormal	EC02
Operation LED and filter LED flickering (1Hz period)	Outdoor temperature sensor abnormal	EC03
Reservation LED filter LED alternating flickering (1Hz period)	Float switch open abnormal	EC04
Reservation LED and filter LED flickering (1Hz period)	Indoor and outdoor communication abnormal	EC05
Operation LED and reservation LED alternating flickering (1Hz period)	Wired remote controller communication abnormal	EC06
Filter LED flickering (1Hz period)	Outdoor pipe temperature sensor abnormal	EC07

### ■ Trouble shooting by outdoor unit error code

ERROR CODE	ERROR DESCRIPTION	REFERENCE PART
*1	Indoor unit room thermistor error	EC01
*5	Indoor unit pipe thermistor error	EC02
*6	Outdoor unit thermistor error	EC03
*9	Float switch open error	EC04
*A	Communication error between indoor unit and outdoor unit	EC05
*C	Communication error between wired remote controller and indoor unit	EC06
*D	Outdoor unit pipe thermistor error	EC07

\* The asterisk mark “ \* ” + “ERROR” CODE of wired remote controller stands for the set number.  
 ex) ERROR CODE “39” is the FLOAT SWITCH OPEN ERROR of SET no.3.

■ Trouble shooting by outdoor unit error cond

ERROR CODE	ERROR DESCRIPTION	REFERENCE PART
LED flickering	Communication error between indoor unit and centralized controller	EC19

### ■ EC01 : Trouble on the thermistor related part of indoor unit.

- EC01 : Trouble on the room thermistor related part of indoor unit.
  - E1 of outdoor unit PCB 7-segment
  - Reservation lamp of wireless receiving board is flickering with 1 Hz.
  - Action items when “\*1” displays on the wired remote controller.

Check point :

- Defect of indoor unit
- Indoor unit thermistor defect

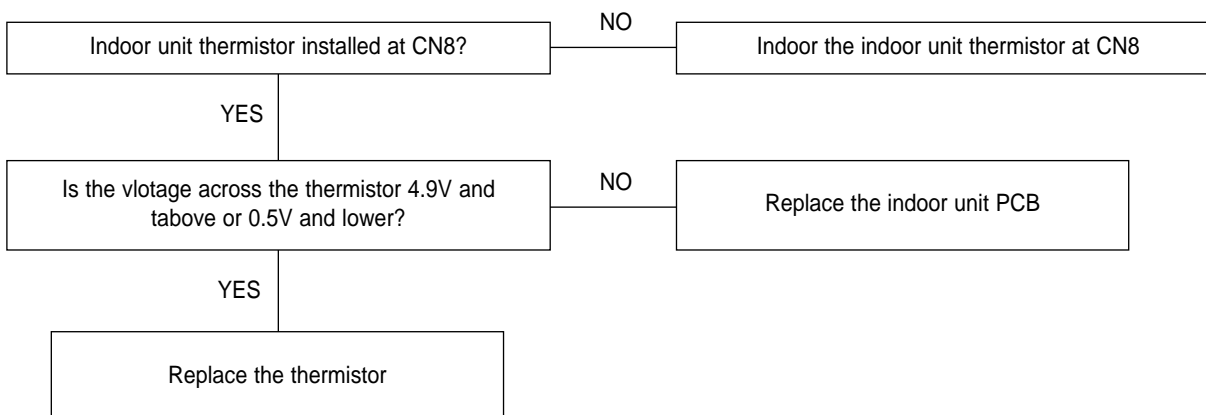

\* “\*” stands for the indoor unit address.

### ■ EC02 : Trouble on the pipe thermistor related part of indoor unit.

- E5 of outdoor unit PCB 7-segment.
- Reservation lamp of wireless receiving board is flickering with 1 Hz.
- Action items when “\*5” displays on the wired remote controller.

Check point :

- Indoor unit PCB defect
- Indoor unit pipe thermistor defect

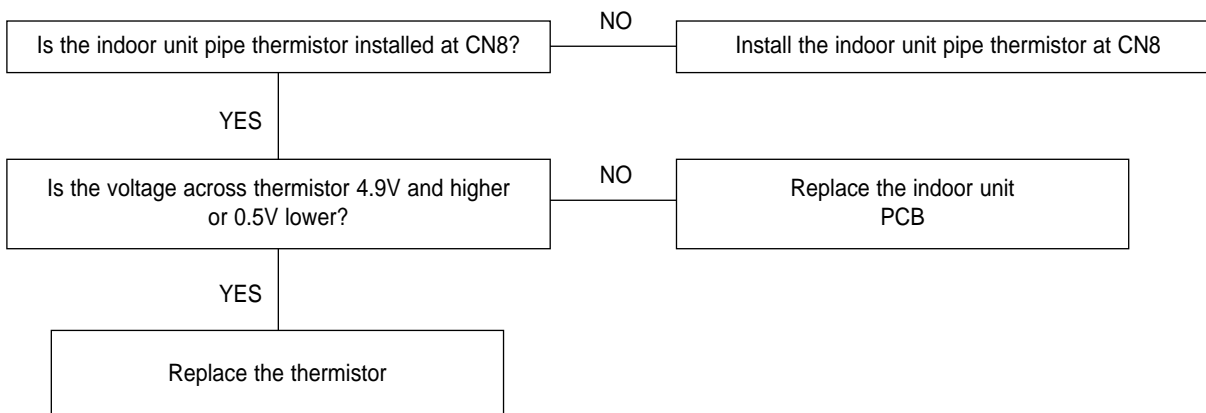

■ EC03 : When the trouble is found on the part related to the outdoor unit thermistor.

- E6 of outdoor unit PCB 7-segment
- Operation lamp and filter lamp of wireless receiving board are flickering with 1Hz.
- Action items when “\*6” displays on the wired remote controller.

Check point :

- Defect of indoor unit
- Indoor unit thermistor defect

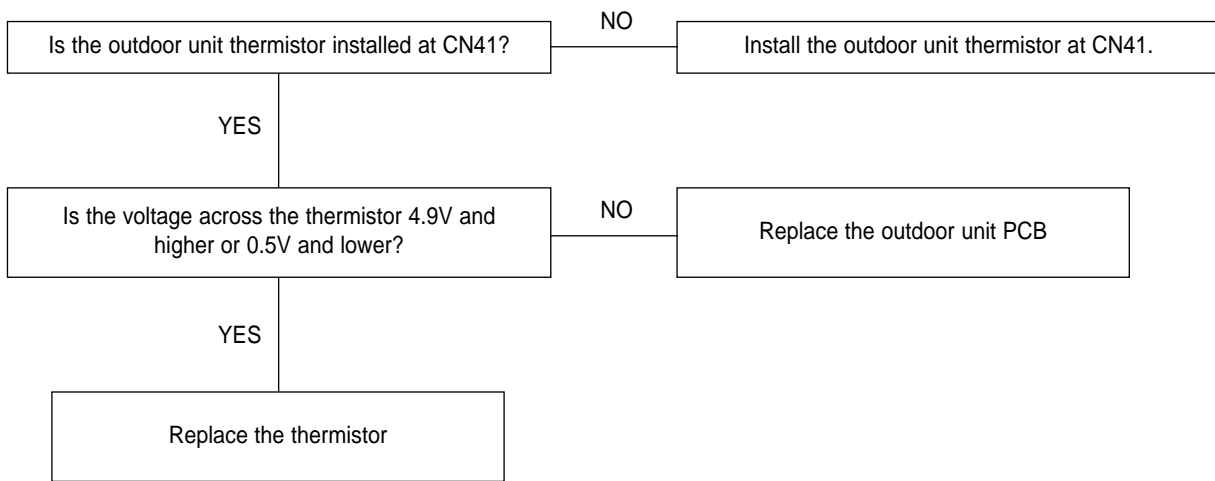

\* “\*” stands for the indoor unit address.

**■ EC04 : When the trouble is found on the drain pump and float switch installed on the indoor unit.**

EC01 : Trouble on the thermistor related part of indoor unit.

- E9 of 7-segment of outdoor unit PCB
- Reservation lamp of wireless receiving board and filter lamp are flickering with 1 Hz.
- Action item when “\*9” displays on the wireless remote controller.

Check point :

- Indoor unit defect
- Drain pump, float switch defect

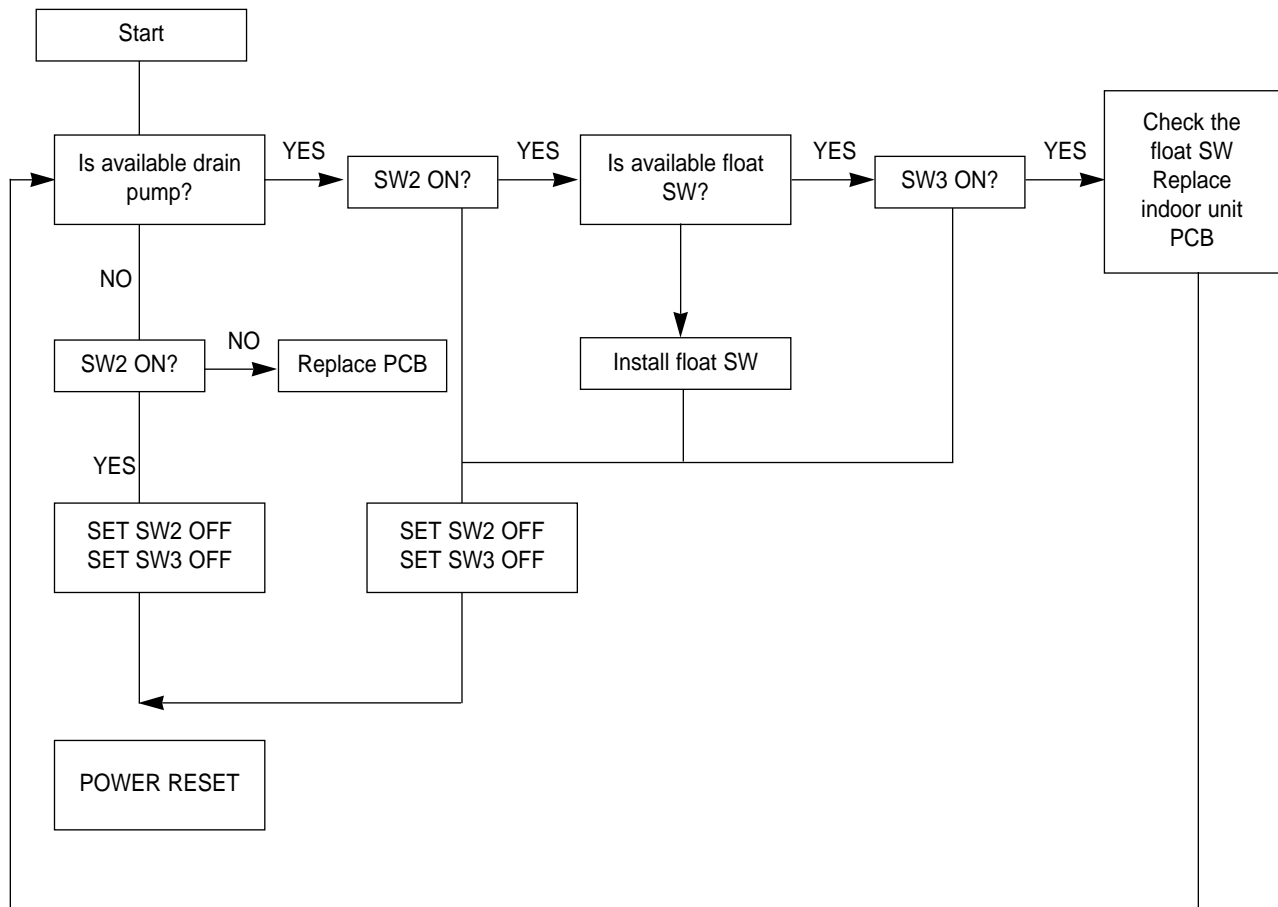

\* “\*” stands for the indoor unit address.

**■ EC05 : When the trouble is found in the communication related part between indoor unit and outdoor unit.**

- EA of 7-segment of outdoor unit PCB.
- Reservation lamp and filter lamp of wireless receiving board is flickering with 1 Hz.
- Action item when “\*A” displays on the wired remote controller.

Check point :

- Indoor unit ↔ outdoor unit mis-connection
- Indoor unit PCB defect
- Outdoor unit PCB defect

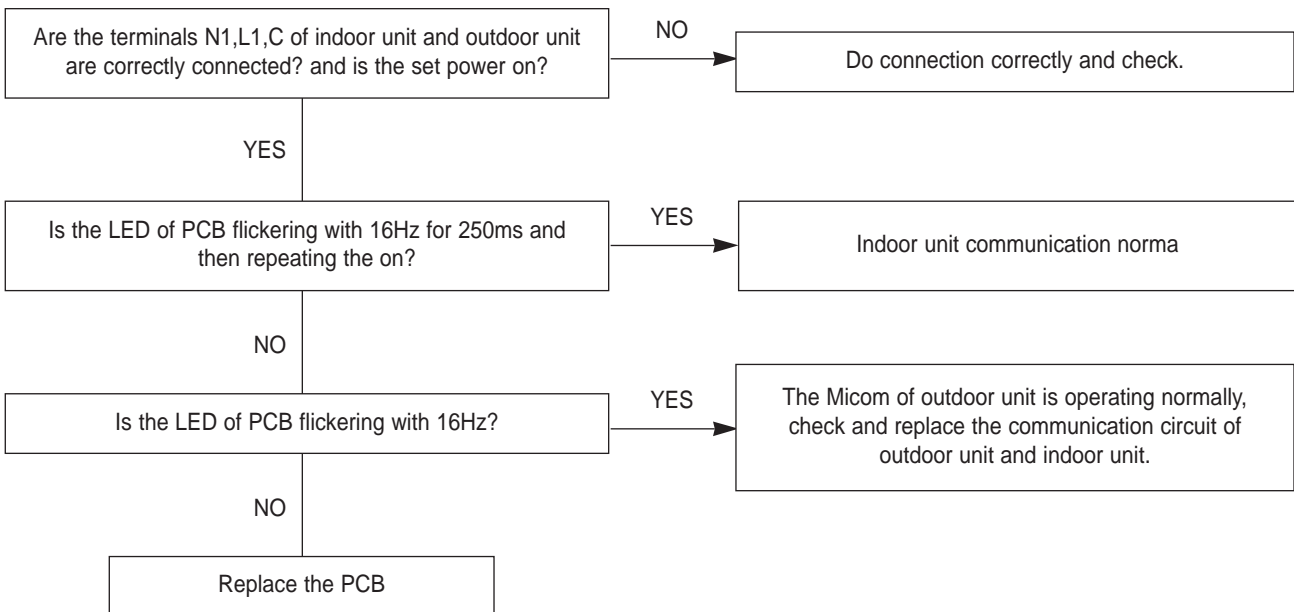

\* “\*” stands for the indoor unit address.

**■ EC06 : When the trouble is found in the communication related part between indoor unit and wired remote controller. (during single operation, not group control)**

- EC of 7-segment of outdoor unit PCB.
- Wireless receiving board lamp and reservation lamp is flickering with 1Hz.
- Action item when “C” displays on the wired remote controller.

Check point :

- Short circuit or mis-connection of the communication line between indoor unit and wireless remote controller
- Indoor unit PCB defect
- Wired remote controller PCB defect

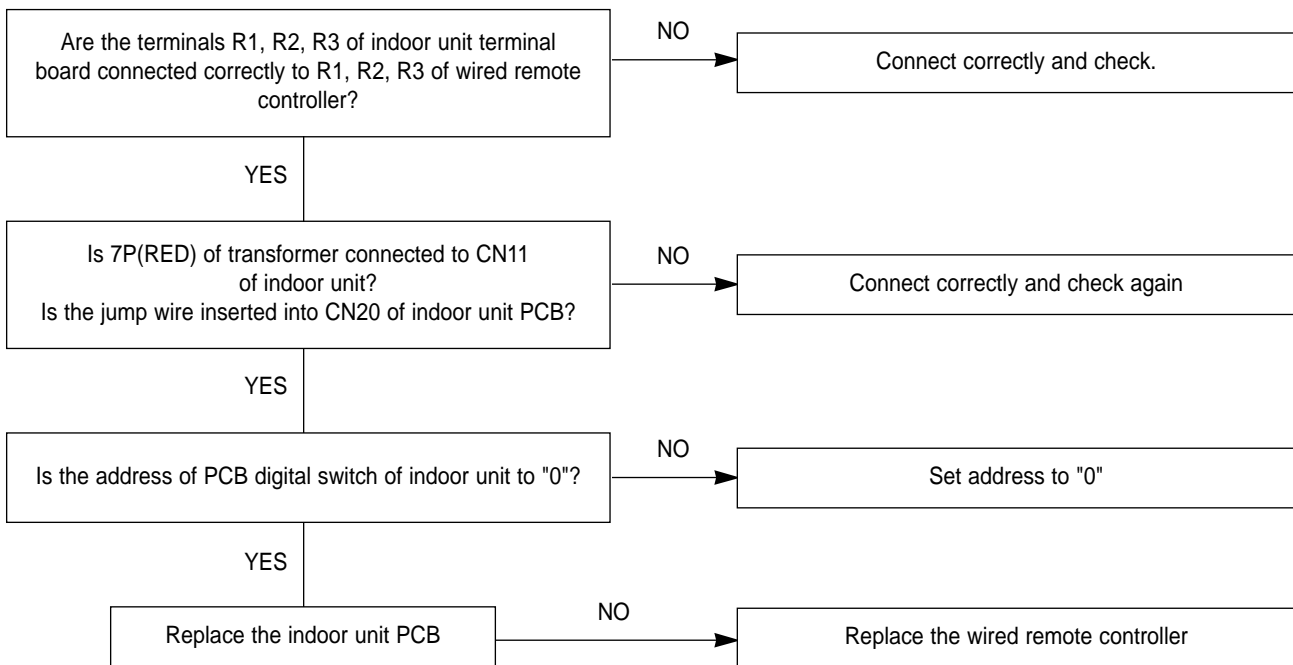

\* “0” stands for the indoor unit address.

### ■ EC07 : When the trouble is found in the communication related part between outdoor unit pipe thermistor.

- ED of 7-segment of outdoor unit PCB.
- Reservation lamp and filter lamp of wireless receiving board is flickering with 1Hz.
- Action item when “D” displays on the wired remote controller.

Check point :

- Indoor unit pipe thermistor available or not
- Indoor unit PCB defect

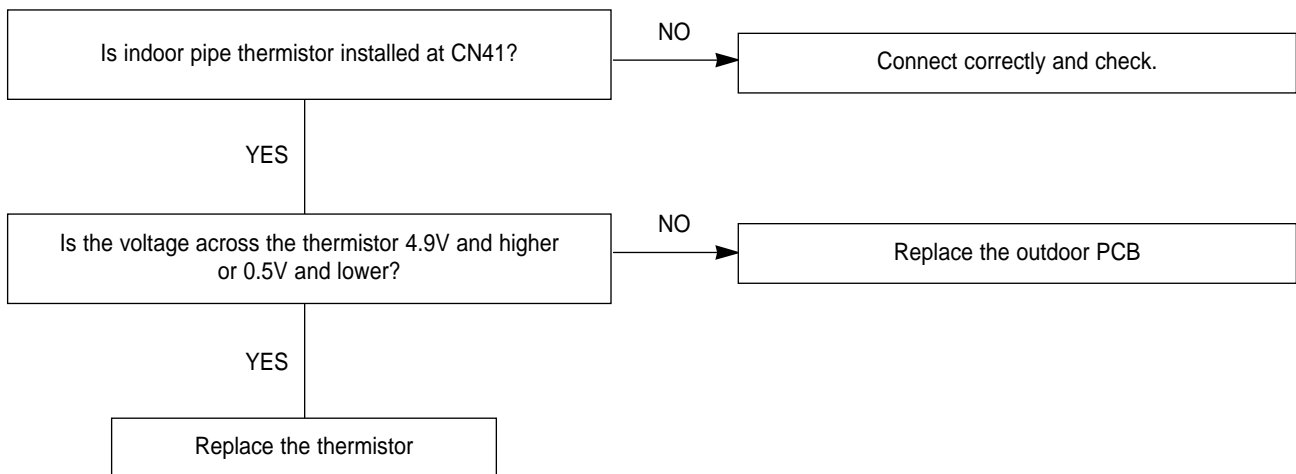

\* “\*” stands for the indoor unit address.



**■ EC08 : When the trouble is found on the part related to the wireless receiving board of the indoor unit.**

Check point :

- Defect of wireless remote controller PCB
- Defect of wireless remote controller receiving board PCB
- Indoor unit PCB defect

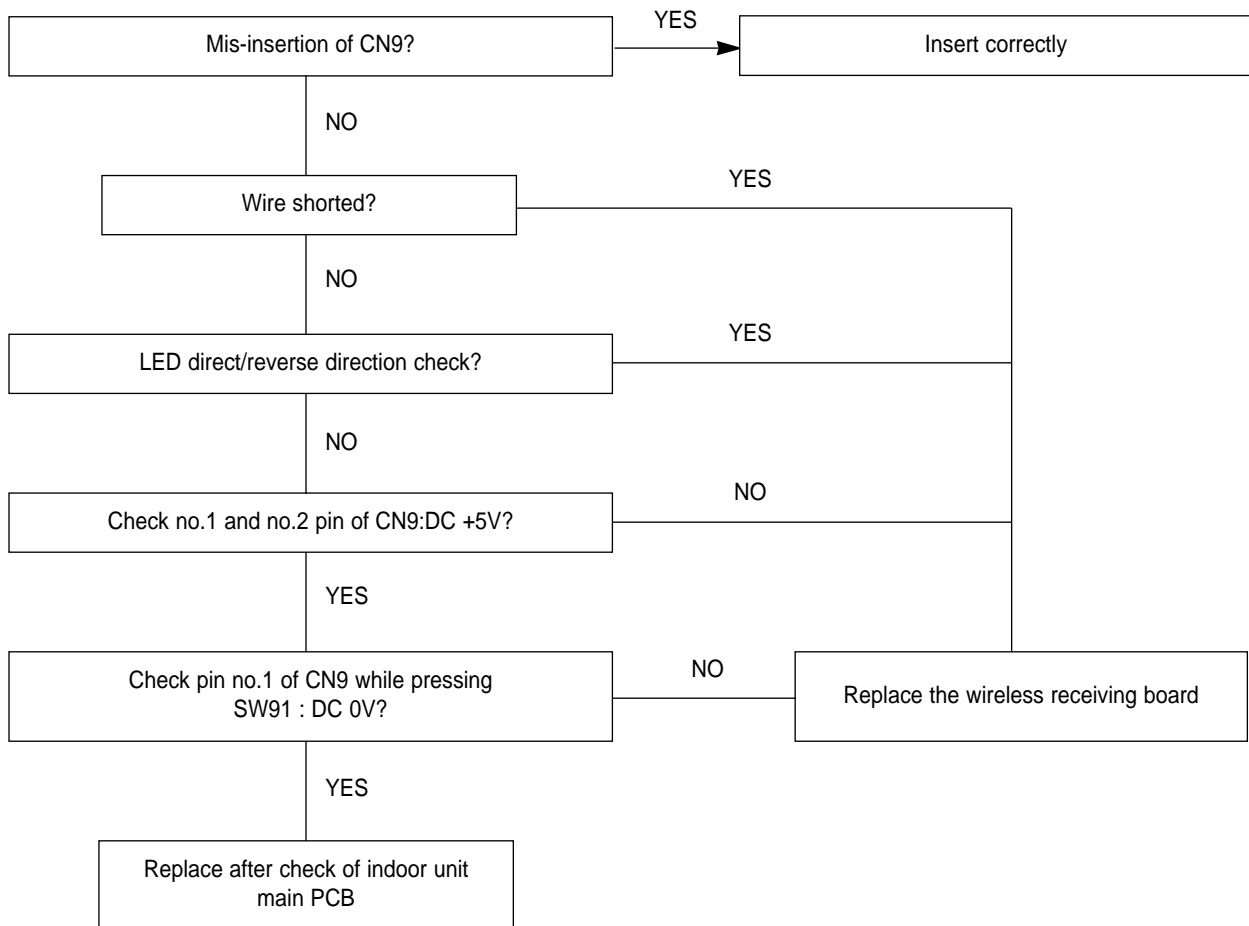

**■ EC09 : When the trouble is found on the part related to the wired remote controller.  
(single operation)**

Check point :

- Defect of communication line between indoor unit and wired remote controller.
- Output of indoor unit Micom
- Defect of wired remote controller PCB
- Indoor unit PCB defect

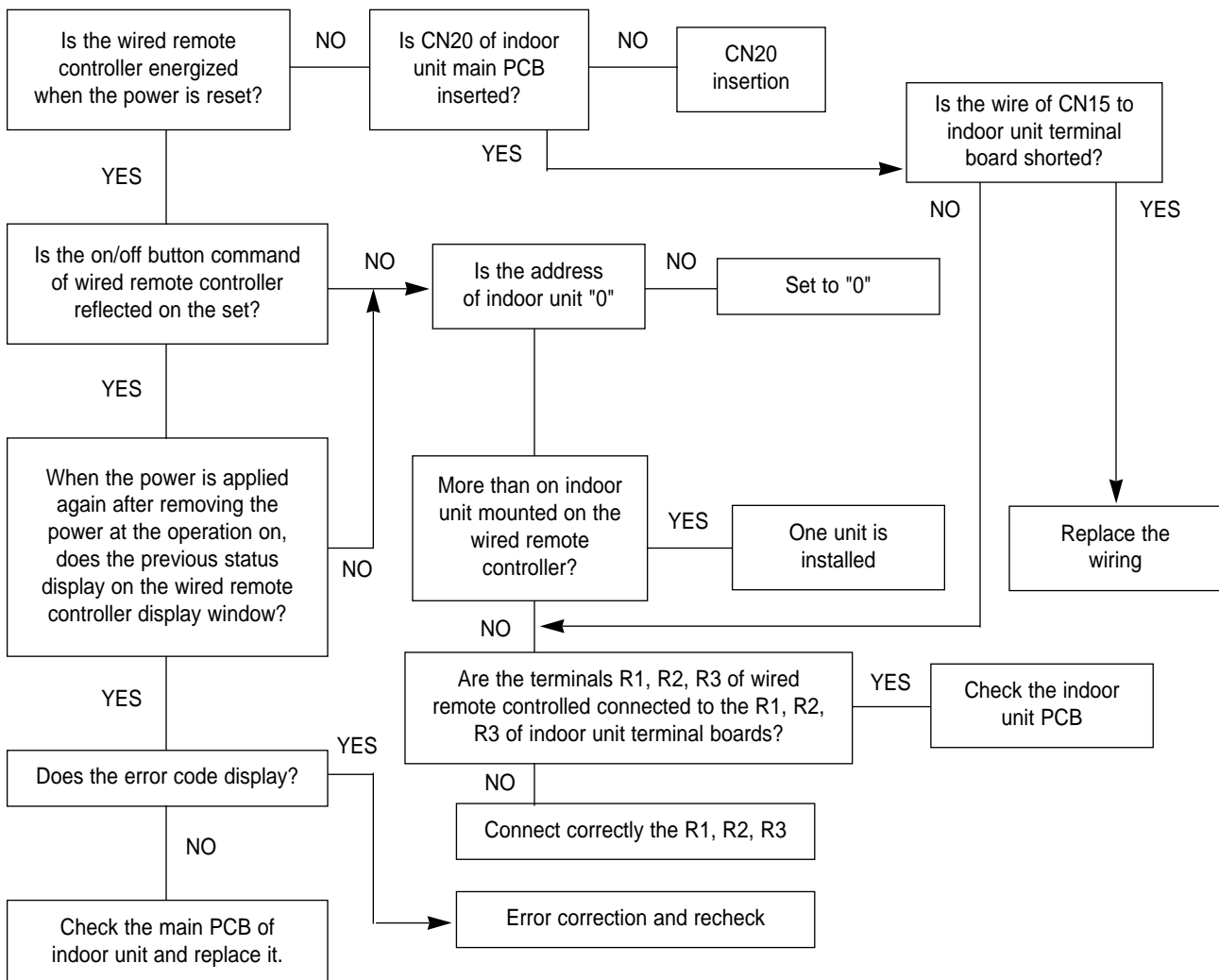

■ EC10 : When the trouble is found on the part related to the fan motor of indoor unit.

Check point :

- Defect of PCB relay of indoor unit.
- Output of indoor unit Micom
- Indoor fan motor defect
- Defect of PCB IC06 of indoor unit

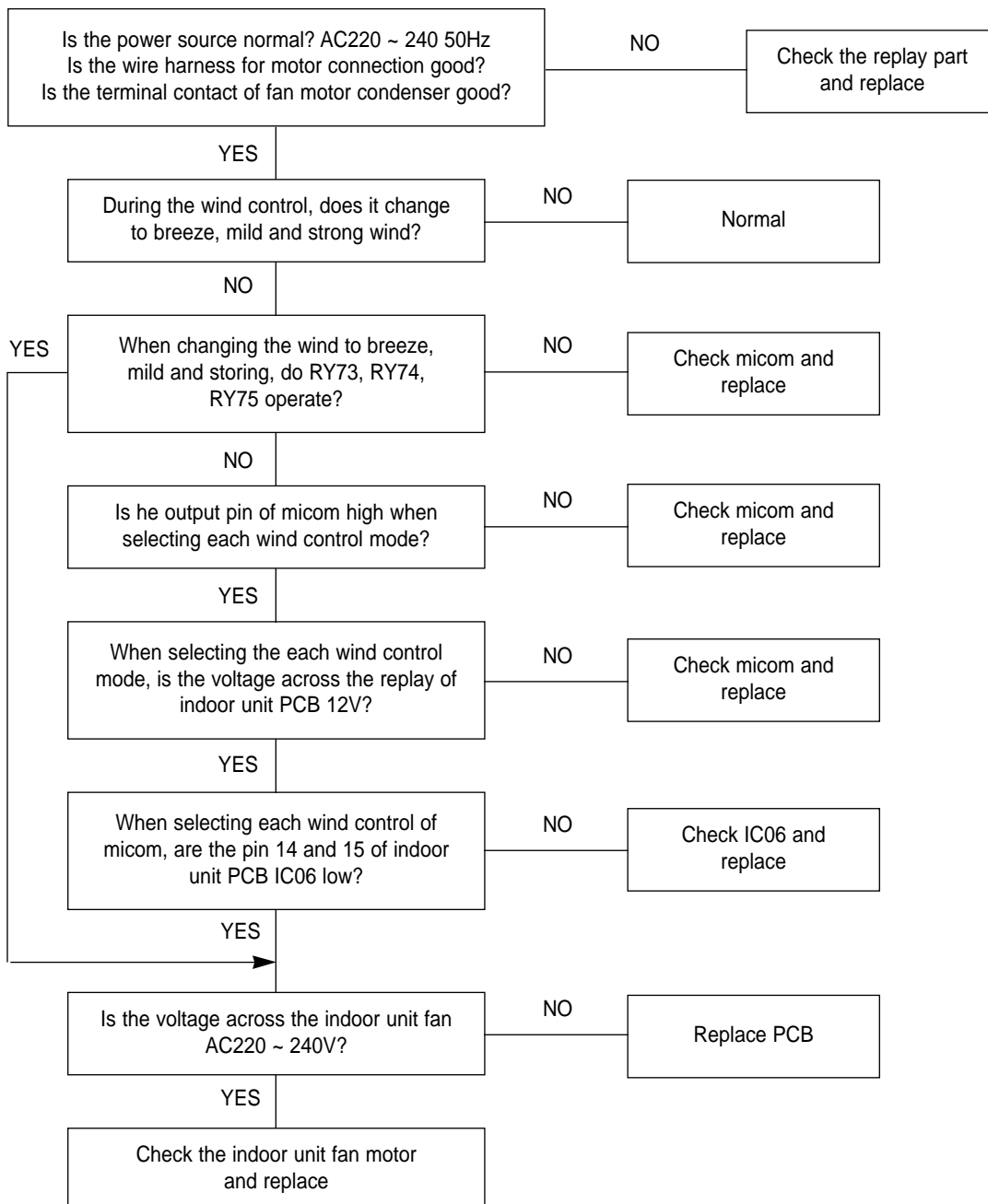

■ EC11 : When the trouble is found on the part related to the fan motor of outdoor unit.

Check point :

- Outdoor unit PCB relay defect
- Output of outdoor unit micom
- Outdoor unit fan motor defect
- Defect of IC07 of outdoor unit PCB

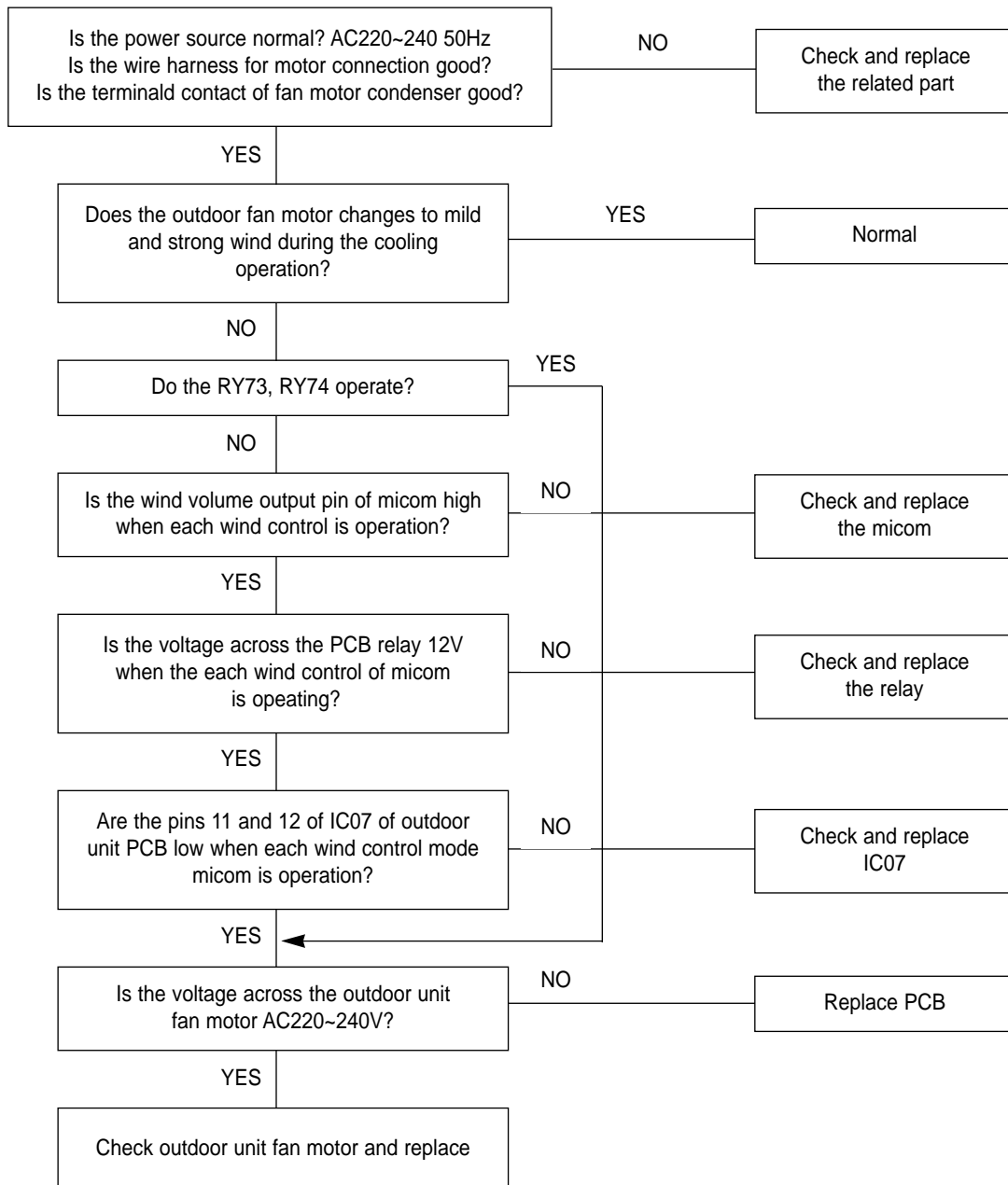

■ EC12 : When the trouble is found on the part related to comp of outdoor unit.

Check point :

- Indoor unit PCB relay defect
- Output of indoor unit micom
- Comp defect
- Magnet switch defect

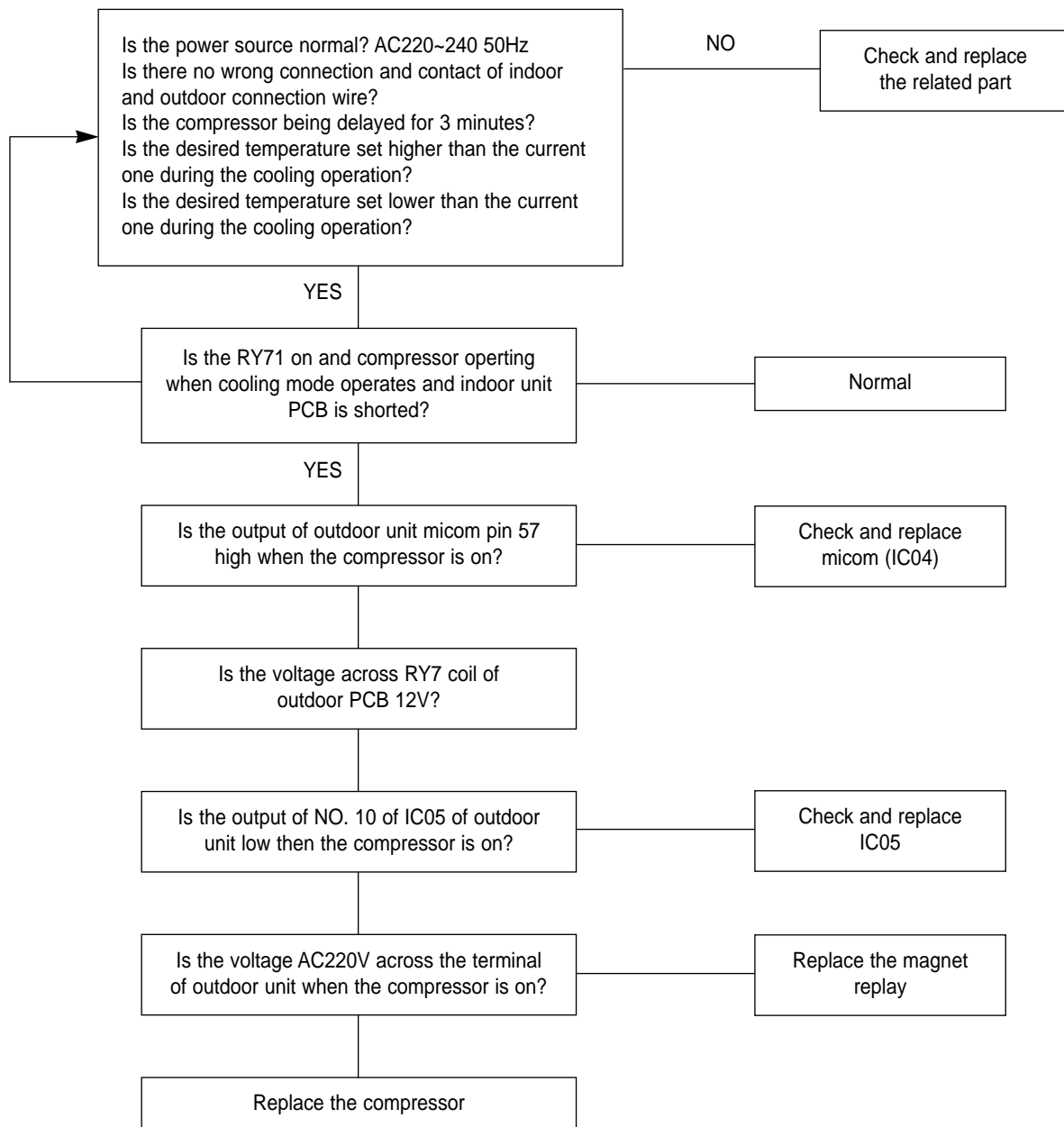

### ■ EC13 : When the trouble is found on the part related to the up & down swing motor of indoor unit (cassette model)

Check point :

- Wire short between indoor unit PCB up & down swing motor connector or bad contact.
- Output of indoor unit micom
- Defect of up and down swing motor

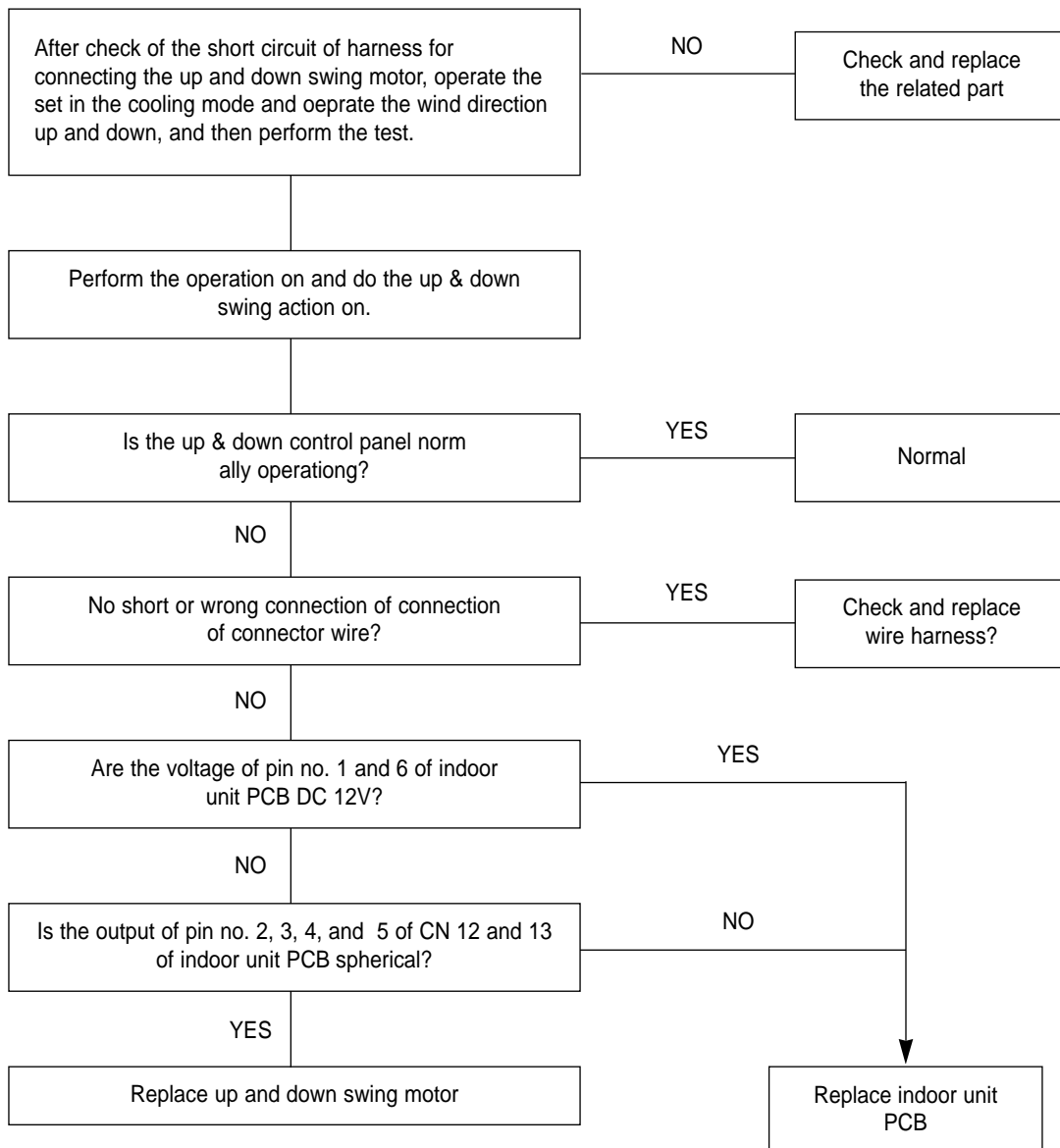

■ EC14 : When the trouble is found on the part related to drain pump of indoor unit.

Check point :

- Indoor unit PCB ↔ Drain pump connector wire, indoor unit Micom No.6 Pin output, IC06 No.6 Pin output.
- Drain pump, RY72, DC12V power, AC220~240V 50Hz power, indoor unit option switch.

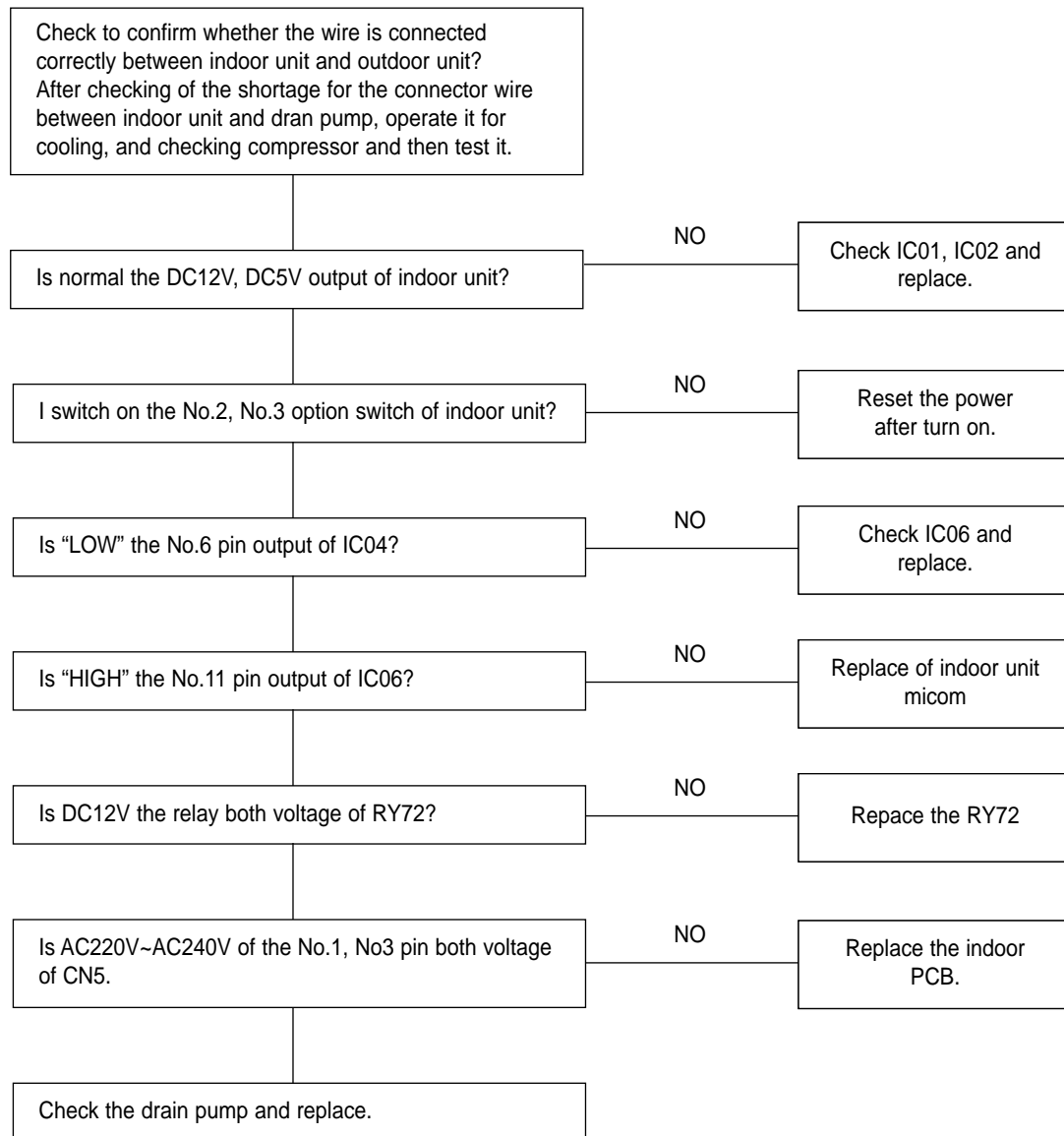

■ EC15 : When the trouble is found on the part related to float switch of indoor unit.

Check point :

- Indoor unit PCB ↔ float switch connector wire, voltage level of indoor unit micom pin no. 55
- Float switch, DC5V power, indoor unit option switch

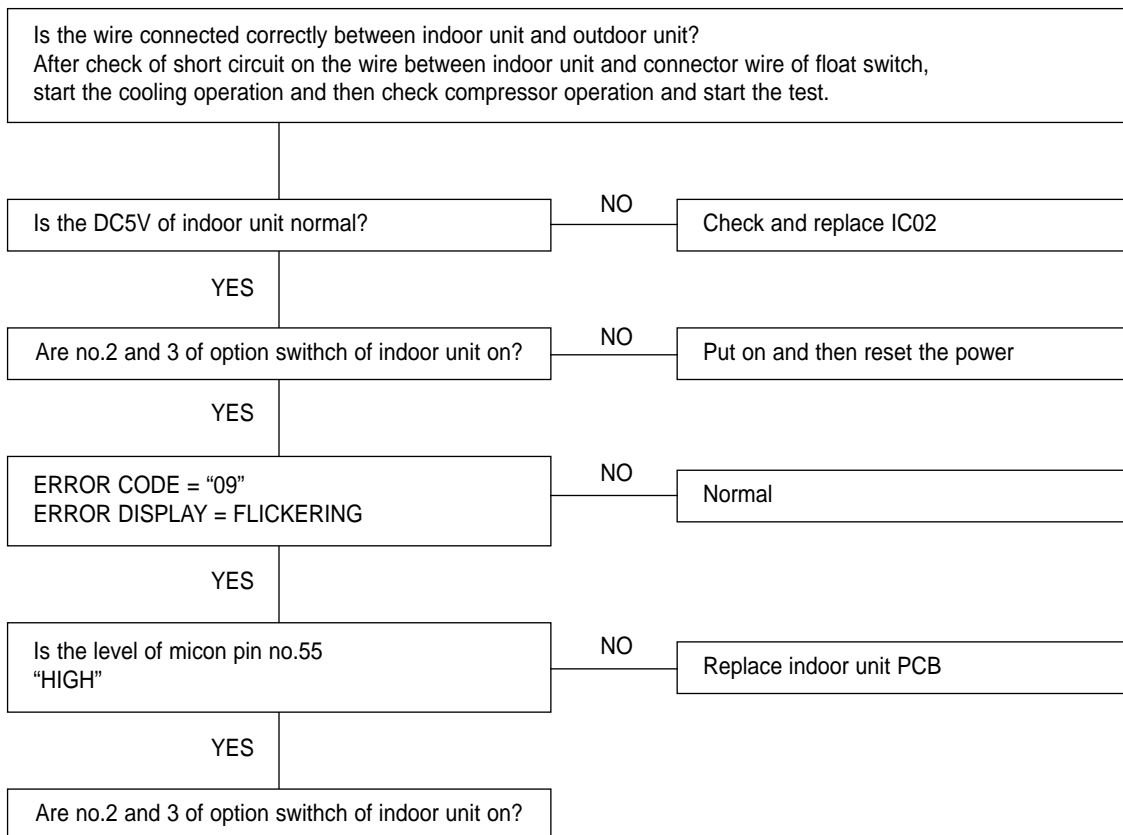



■ EC16 : When the trouble is found on the part related to ventilator of indoor unit.

Check point :

- Indoor unit PCB ↔ ventilator connector wire, output voltage of indoor unit micom pin No. 5
- Ventilator, DC 12V power, DC5V power, indoor unit option switch.

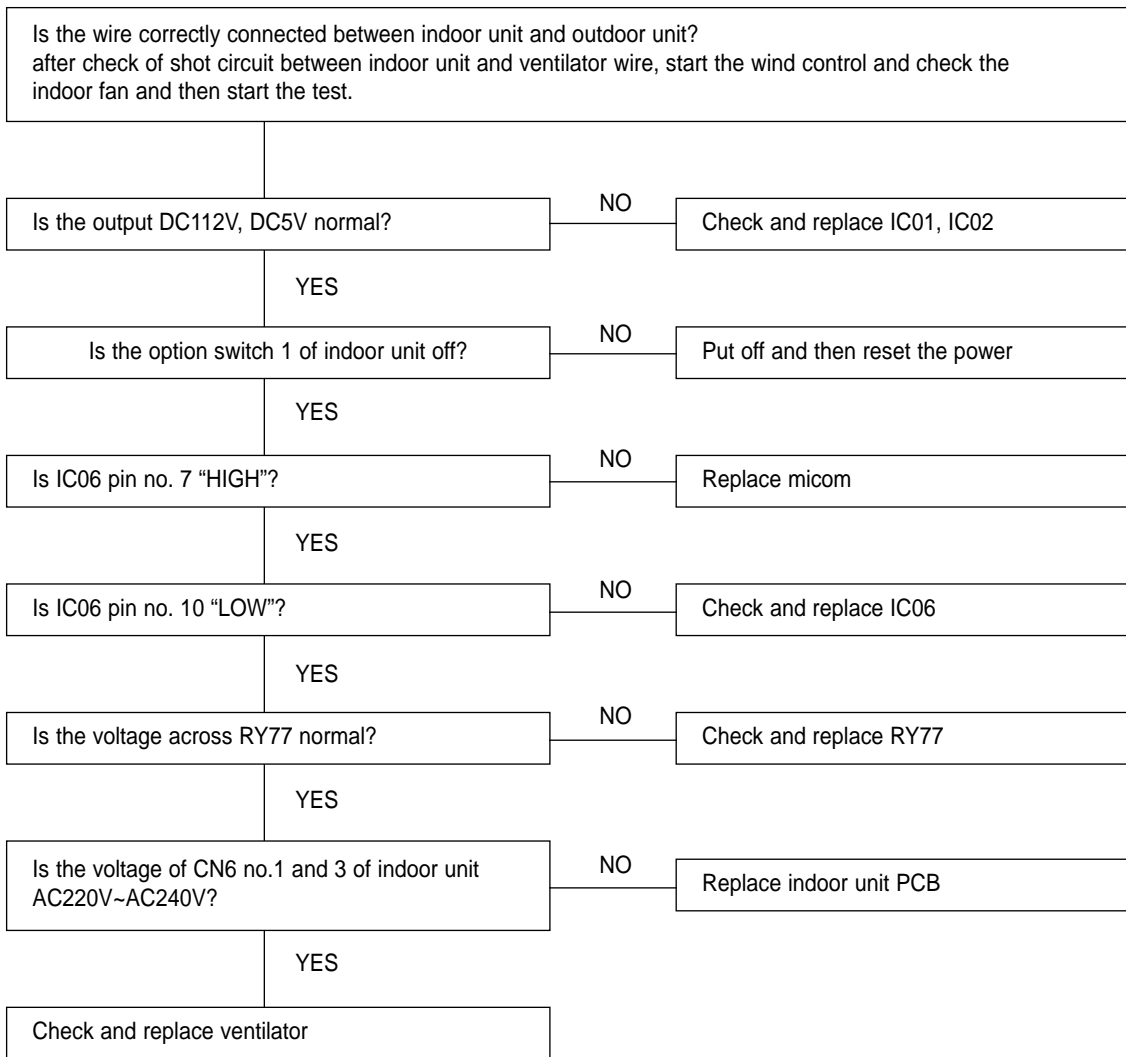

■ EC17 : When the trouble is found on the part related to power system of indoor unit.

Check point :

- Indoor unit AC220V~AC240V input voltage, DC12V output, DC5V output, output voltage of pin no.2 and 3 of CN15.
- Power transformer, F101, F102, F701

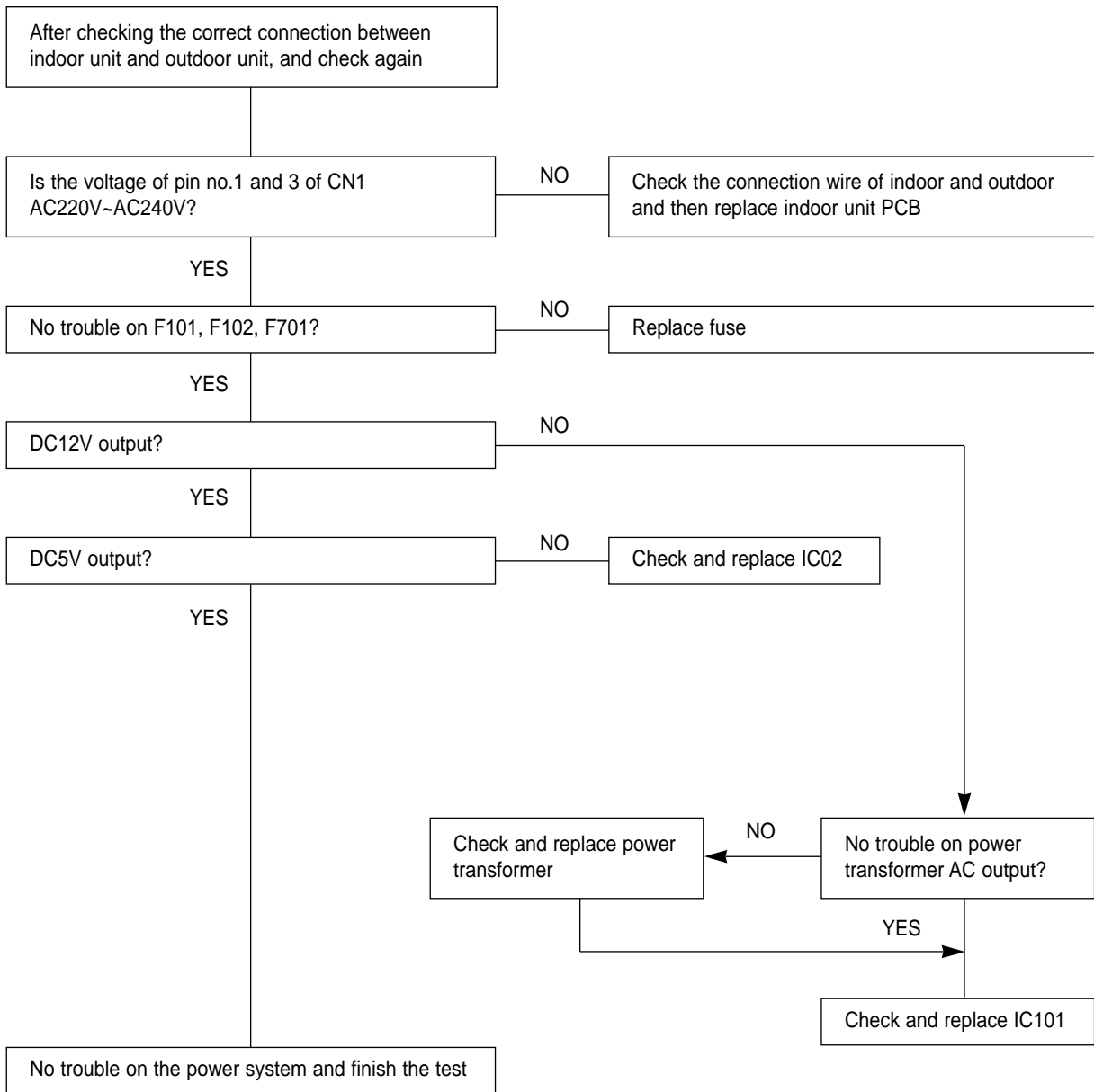

■ EC18 : When the trouble is found on the part related to power system of output unit.

Check point :

- Outdoor unit AC220V~AC240V input power, DC12V output, DC5V output
- Power transformer, F101, F701

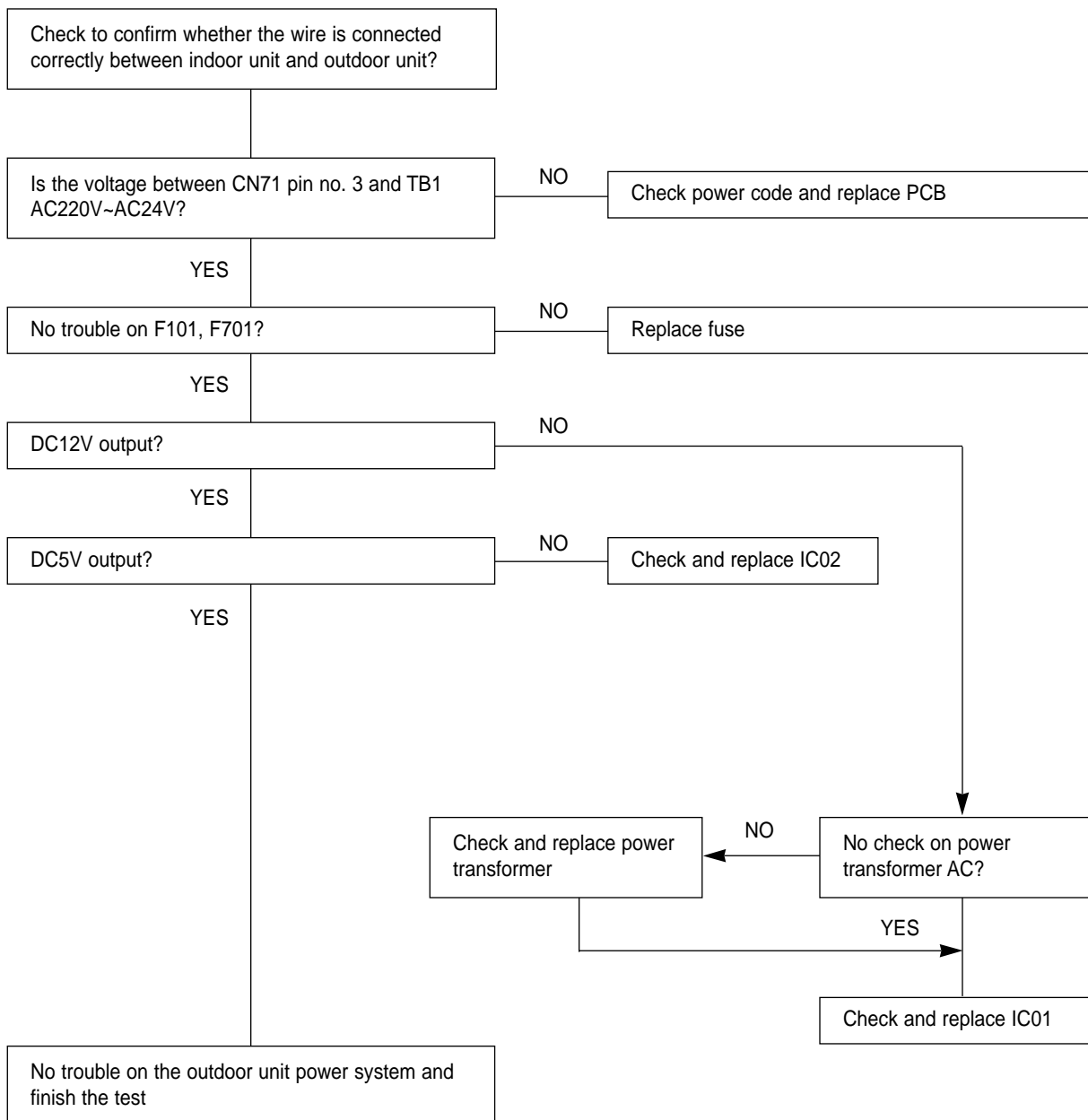

**■ EC19 : When the centralized controller lamp is flickering. (during centralized control)**

Check point :

- Defect on the address assignment for the relay equipment connected with centralized controller.
- Defect on centralized controller PCB
- Defect on the indoor unit PCB

